

**AIR FORCE TO 1-1-686
ARMY TM 55-1500-331-34
NAVY (NAVAIR) 15-01-4**

TECHNICAL MANUAL

ORGANIZATION LEVEL

**DESERT STORAGE
PRESERVATION AND PROCESS
MANUAL FOR AIRCRAFT, AIRCRAFT ENGINES, AND
AIRCRAFT AUXILIARY POWER UNIT ENGINES**

BASIC AND ALL UPDATES HAVE BEEN MERGED TO MAKE THIS A COMPLETE PUBLICATION.

DISTRIBUTION STATEMENT A - Approved for public release; distribution is unlimited. PA Case Number 14-09238. Other requests for this document shall be referred to 406 SCMS/GUEE, Robins AFB, GA 31098. Questions concerning technical content shall be referred to AFLCMC/WNZ.

Published Under Authority of the Secretaries of the Air Force, Army and Navy

24 MARCH 2020

CHANGE 5 - 8 DECEMBER 2023

INSERT LATEST CHANGED PAGES. DESTROY SUPERSEDED PAGES.

LIST OF EFFECTIVE PAGES

NOTE The portion of the text affected by the changes is indicated by a vertical line in the outer margins of the page. Changes to illustrations are indicated by shaded or screened areas, or by miniature pointing hands.

Dates of issue for original and changed pages are:

Original0.24 March 2020 Change3.6 February 2023
 Change15 August 2022 Change4.30 June 2023
 Change2.16 January 2023 Change5.8 December 2023

TOTAL NUMBER OF PAGES IN THIS PUBLICATION IS 124, CONSISTING OF THE FOLLOWING:

Page No.	*Change No.	Page No.	*Change No.	Page No.	*Change No.
Title	5				
A	5				
i - iii	0				
iv	4				
v - ix	2				
x Blank	0				
xi - xii	0				
xiii - xvi	2				
xvii	0				
xviii Blank	0				
xix - xxvi	0				
1-1 - 1-14	0				
2-1 - 2-12	0				
2-13	2				
2-14 Blank	0				
3-1 - 3-2	0				
4-1	5				
4-2 - 4-15	0				
4-16 Blank	0				
5-1 - 5-3	0				
5-4 Blank	0				
6-1 - 6-2	0				
7-1 - 7-2	4				
7-2.1 Added	4				
7-2.2 Blank	4				
7-3	0				
7-4	1				
7-5 - 7-6	2				
7-6.1 Added	2				
7-6.2 Blank	2				
7-7 - 7-11	0				
7-12 Blank	0				
8-1 - 8-12	0				
9-1 - 9-4	0				
10-1 - 10-6	0				
11-1	0				
11-2 Blank	0				
A-1 - A-4	0				

* Zero in this column indicates an original page.

TABLE OF CONTENTS

Chapter		Page
	LIST OF ILLUSTRATIONS	ix
	LIST OF TABLES	ix
	INTRODUCTION	xi
	SAFETY SUMMARY	xix
1	GENERAL INFORMATION	1-1
1.1	GENERAL	1-1
1.1.1	Material Listing	1-1
1.2	CLEANING	1-1
1.3	COMPONENT CLEANING	1-1
1.3.1	Vacuum Cleaning	1-1
1.3.2	Detergent Hand Cleaning	1-1
1.3.3	Solvent Hand Cleaning	1-1
1.3.4	Canopy Seals and Mating Surfaces	1-1
1.3.5	Special Cleaning Requirements	1-2
1.4	HAND CLEANING METHOD	1-2
1.4.1	Light Soil	1-2
1.4.2	Moderate Soil	1-2
1.4.3	Heavy Soil	1-2
1.4.4	Cleaning Compound	1-2
1.4.5	Hand Cleaning	1-2
1.4.6	MIL-PRF-680 Cleaning Procedure	1-3
1.5	GENERAL VISUAL INSPECTION	1-3
1.5.1	Inspection Aids	1-3
1.5.2	Area Preparation	1-3
1.5.3	Visual Inspection	1-3
1.6	AMARG AEROSPACE ASSET MARKING	1-3
1.7	AMARG SUPPORT FIXTURES	1-4
1.8	AMARG DESERT OPERATIONS PROCEDURES	1-4
1.8.1	Safe for AMARG Desert Operations	1-4
1.8.2	Engine Removal	1-5
1.8.3	Partial Lifting of Assets	1-5
1.8.4	Alternate Strut Inflation	1-6
1.8.5	Alternate Strut Deflation	1-7
1.9	AMARG COMMON PROCEDURES	1-7
1.9.1	MA-1 Portable Oxygen System Depletion	1-7
1.9.2	Underwater Acoustic Beacon Battery Removal	1-7
1.9.3	Temporary Install	1-8
1.9.3.2	Components	1-8
1.9.3.3	Aircraft Top and Side Panels	1-8
1.9.3.4	Aircraft Bottom Panels	1-8
1.10	STORAGE AIRCRAFT WHEEL AND TIRE REMOVAL AND INSTALLATION	1-8
1.10.1	Aircraft preparation	1-8
1.10.2	Wheel and tire inspection	1-8
1.10.3	Wheel and Tire Assembly Removal and Installation	1-9
1.11	MUSEUM AIRCRAFT (INCLUDES MUSEUM GENERAL SERVICES ADMINISTRATION (GSA) TRANSFERS)	1-9
1.11.1	Struts, Wheels and Tires	1-9

TABLE OF CONTENTS - CONTINUED

Chapter		Page
1.11.2	Instruments	1-9
1.11.3	Afterburner or Augmentors	1-9
1.11.4	Lower Explosive Limit Checks.	1-9
2	LONG-TERM STORAGE PRESERVATION PROCEDURES	2-1
2.1	GENERAL	2-1
2.2	PRE-INDUCTION PROCEDURES.	2-1
2.2.1	Non Fly-in Aircraft or Engines.	2-1
2.2.2	Induction Procedures	2-1
2.3	PRESERVATION PROCEDURES	2-3
2.3.1	Fuel System Preparation	2-3
2.3.2	Fuel System Preservation.	2-3
2.3.2.1	Fill and Drain Method	2-3
2.3.2.2	Fuel Cell Mistng Method	2-4
2.3.3	Power Plant Preservation.	2-4
2.3.3.1	Operational Method	2-4
2.3.3.2	Alternate Motoring Method	2-4
2.3.3.3	Cold Preservation Method	2-5
2.3.3.4	APUs	2-5
2.3.4	Helicopter Transmissions and Gearboxes	2-5
2.4	STORAGE PREPARATION PROCEDURES	2-5
2.4.1	Electrical Systems	2-5
2.4.2	Pneumatic Systems.	2-5
2.4.3	Photographic Systems.	2-5
2.4.4	Safety and Survival Systems	2-6
2.4.5	Oxygen Systems	2-6
2.4.6	Utility Systems	2-6
2.4.7	Additional Requirements	2-6
2.5	CLEANING, LUBRICATION AND CORROSION PROCEDURES.	2-7
2.5.1	Pre-Wash Lubrication	2-7
2.5.2	Aircraft Wash	2-7
2.5.3	General External Corrosion Prevention and Control.	2-8
2.5.4	Corrosion Prone Areas	2-8
2.5.5	Corrosion Treatment.	2-9
2.5.6	Electrical Connectors	2-9
2.5.7	Lights.	2-9
2.5.8	Refueling Probes	2-10
2.5.9	Static Vent Systems	2-10
2.5.10	Arresting Gear.	2-10
2.5.11	Camera Mounts	2-10
2.6	SEAL AIRCRAFT	2-10
2.7	IN STORAGE INSPECTION.	2-10
2.8	SEVERE WEATHER INSPECTION.	2-10
3	PRESERVATION AND INSPECTION OF UNINSTALLED ENGINES, PROPELLERS, HELICOPTER BLADES AND STORAGE DEVICES.	3-1
3.1	GENERAL	3-1
3.2	UNINSTALLED ENGINE, HELICOPTER BLADE AND PROPELLER INDUCTION.	3-1
3.3	INSPECTION REQUIREMENTS.	3-1
3.3.1	Safe and Secure Check	3-1
3.4	PRESERVATION OF STORED ENGINES	3-1

TABLE OF CONTENTS - CONTINUED

Chapter		Page
3.5	SHIPPING ASSETS	3-1
4	BARRIER SYSTEMS	4-1
4.1	PART A - PROCESS:	4-1
4.1.1	General	4-1
4.1.1.1	General Guidance	4-1
4.1.2	Coating Description	4-1
4.1.2.1	MIL-PRF-6799, Type II, Coatings	4-1
4.1.2.2	Black Base Coat	4-1
4.1.3	Equipment	4-1
4.1.4	Preparation of Surfaces for Application of Sprayable Strippable Coatings	4-1
4.1.4.1	Surface Cleaning	4-2
4.1.4.2	Release Agents	4-2
4.1.4.3	Vents and Drains	4-2
4.1.4.4	Filler Materials	4-2
4.1.4.5	Desiccant Suspension Devices	4-2
4.1.4.6	Mask for Overspray	4-4
4.1.4.7	Final Inspection Prior to Application of Coating	4-4
4.1.5	Tape Application	4-4
4.1.6	Barrier Material, Fiberboard and Vinyl Closures	4-6
4.1.6.1	Deteriorated or Unpainted Composite Surfaces	4-6
4.1.7	Masking for Overspray	4-6
4.1.8	Preparation of Sprayable Strippable Coatings	4-6
4.1.8.1	Initial Agitation of Sprayable Strippable Coatings	4-6
4.1.9	Application of Sprayable Strippable Coating	4-7
4.1.9.1	Black Base Coat	4-7
4.1.9.2	White Top Coat	4-7
4.1.10	Repair of Existing Coated Surfaces	4-8
4.1.11	Repair of Eroded Top Coat	4-8
4.1.12	Marking	4-8
4.1.13	Removal of Sprayable Strippable Coatings	4-8
4.1.14	Cutting Sprayable Strippable Coating	4-9
4.2	PART B - SHRINK WRAP PROCEDURES	4-9
4.2.1	Shrink Wrap	4-9
4.3	PART C - SEALING DIAGRAM DEVELOPMENT PROCESS	4-10
4.3.1	Purpose	4-10
4.3.2	Sealing Diagram Development	4-10
4.3.2.1	Aircraft Covers	4-12
4.3.2.2	Sealing Diagram	4-12
4.3.3	Sealing Diagram Prototype Test	4-13
4.3.3.1	Sealing Diagram Prototype Testing	4-13
5	RECLAMATION	5-1
5.1	GENERAL	5-1
5.2	PARTS RECLAMATION PROCEDURES	5-1
5.3	SEALING ASSETS AFTER PART RECLAMATION	5-2
5.4	AIRCRAFT STRUCTURAL CUTS	5-3
6	DEPRESERVATION FOR RECURRING PRESERVATION	6-1
6.1	GENERAL	6-1

TABLE OF CONTENTS - CONTINUED

Chapter		Page
6.2	DEPRESERVATION	6-1
6.2.1	Preparation for depreservation	6-1
6.2.2	Fuel System Depreservation	6-1
6.2.3	Aircraft Power Plant Depreservation	6-2
6.2.3.1	Preparation	6-2
6.2.3.2	Operational Depreservation Method	6-2
6.2.3.3	Alternate Motoring Depreservation Method	6-2
6.2.4	Helicopter Transmission and Gearbox Depreservation	6-2
7	AIRCRAFT TOWING AND MOORING	7-1
7.1	GENERAL	7-1
7.2	GENERAL TOWING INSTRUCTIONS	7-1
7.2.1	Alternate Tow Bars	7-1
7.2.2	Tow Team	7-1
7.2.2.1	Tow Team Supervisor	7-1
7.2.2.2	Tow Vehicle Operator	7-1
7.2.3	AMARG Towing Operations	7-1
7.2.4	Towing on Prepared Surfaces	7-2
7.2.5	Towing on Unprepared Surfaces	7-2.1
7.3	STORAGE AIRCRAFT TOWING PROCEDURES	7-3
7.3.1	Preparation for Towing	7-3
7.3.2	Tow aircraft	7-5
7.3.3	Local Manufacture of Desert Storage Chocks and Straps	7-5
7.4	STORAGE AIRCRAFT TIRE INSPECTION AND SERVICING PROCEDURES	7-6.1
7.4.1	AMARG Storage Aircraft Tire Inspection	7-6.1
7.4.2	Reseating Tire Bead	7-7
7.4.3	Servicing Uninstalled Tires	7-7
7.4.4	Servicing Installed Tires	7-8
7.5	MOORING STORAGE AIRCRAFT	7-9
7.5.1	Mooring Aircraft	7-9
7.6	MOORING AIRCRAFT WITHOUT MOORING POINTS PRESENT	7-10
7.7	SECURING REMOVED AIRCRAFT COMPONENTS (NOT IN STORAGE CONTAINERS)	7-10
8	PREPARATION FOR FERRY FLIGHT	8-1
8.1	GENERAL	8-1
8.2	REQUIREMENTS	8-1
8.2.1	Aircraft Preparation	8-1
8.2.2	Lubrication	8-1
8.2.3	Interior Preparation	8-1
8.2.4	Inspection	8-1
8.2.5	Required Operable Systems	8-1
8.2.6	Loose and Emergency Equipment	8-1
8.2.7	Inventory aircraft	8-1
8.2.8	Weight and Balance	8-1
8.2.9	Safety of Flight Directives	8-1
8.2.10	Scheduled Maintenance Requirements	8-1
8.3	AIRFRAME SYSTEMS	8-2
8.3.1	Radomes	8-2
8.3.2	Access Doors	8-2
8.3.3	Bilges	8-2

TABLE OF CONTENTS - CONTINUED

Chapter		Page
8.3.4	Cables	8-2
8.3.5	Canopies	8-2
8.3.6	Windshields	8-2
8.3.7	Cockpit Enclosures and Cabin Doors	8-2
8.3.8	Pressurized Aircraft	8-2
8.3.9	Cockpits	8-2
8.3.10	Escape Chutes and Doors	8-2
8.3.11	Fairings	8-2
8.3.12	Fuselage, Wings, and Empennage	8-2
8.3.13	Hull Aircraft	8-2
8.3.14	Hinges	8-2
8.3.15	Composite Surfaces	8-2
8.4	MECHANICAL CONTROLS	8-2
8.4.1	Helicopter Mechanical Controls	8-3
8.4.2	Wing Fold Mechanisms	8-3
8.5	MOVEABLE SURFACES	8-3
8.5.1	Hydraulically Actuated Control Surfaces	8-3
8.5.2	Composite Surfaces	8-3
8.5.3	Aircraft Flaps with Jackscrews and Tracks	8-3
8.6	SEATS (EXCEPT EJECTION SEATS)	8-3
8.7	SURFACE CONTROL LOCKS	8-3
8.8	TRIM TAB CONTROLS	8-3
8.9	ARMAMENT SYSTEMS	8-3
8.10	DRIVE AND GEARBOX SYSTEMS	8-4
8.10.1	Aircraft/Engine Gearboxes	8-4
8.10.2	Helicopter Main Transmissions and Intermediate/Tail Rotor Gearboxes	8-4
8.10.3	Transmission and Clutch Mechanisms	8-4
8.10.4	Tail Rotor Shafts	8-4
8.10.5	Rotor Heads	8-4
8.11	ELECTRICAL/ELECTRONIC/FIRE CONTROL SYSTEMS	8-4
8.11.1	Antennas	8-4
8.11.2	Batteries	8-4
8.11.3	Connectors	8-4
8.11.4	Lights	8-4
8.11.5	Pylon Fittings	8-4
8.11.6	Starters and Generators	8-4
8.11.7	Emergency Generators	8-4
8.11.8	Multi-engine Installations	8-4
8.12	TRANSMITTING, RECEIVING, NAVIGATING, SEARCH AND RECOGNITION (IFF) EQUIPMENT	8-4
8.12.1	Intercom Equipment	8-4
8.12.2	Directional Finding Equipment	8-4
8.12.3	Compasses	8-5
8.12.4	Identify Friend or Foe (IFF) or Selective Identification Feature (SIF) Equipment	8-5
8.13	FUEL SYSTEMS	8-5
8.13.1	Fuel System	8-5
8.13.2	Fuel Tank Foam Reinstallation	8-5
8.13.3	Fuel Tank Foam in Aircraft Tanks During Storage	8-5
8.13.4	Cells	8-5
8.13.5	Unusable Fuel Cells	8-5
8.13.6	Emergency Fuel Systems	8-6
8.13.7	Strainers and Filters	8-6
8.13.8	Filler Caps	8-6
8.14	HYDRAULIC SYSTEMS	8-6

TABLE OF CONTENTS - CONTINUED

Chapter		Page
8.14.1	Partially Disassembled Systems	8-6
8.14.2	Hydraulic Systems	8-6
8.14.3	Hydraulic System Contamination Check	8-6
8.14.4	Actuator Piston Rods	8-6
8.14.5	Emergency Systems	8-6
8.14.6	Fluid Reservoirs	8-6
8.14.7	Pressure Accumulators	8-6
8.14.8	Boost Units	8-6
8.14.9	Hydraulic Lines	8-6
8.15	PNEUMATIC SYSTEMS	8-6
8.15.1	Partially Disassembled Systems	8-6
8.15.2	Pneumatic Lines	8-6
8.15.3	Pneumatic Systems	8-6
8.15.4	Nitrogen/Air Bottles	8-7
8.15.5	Air Compressors	8-7
8.15.6	Chemical Air Dyers	8-7
8.16	INSTRUMENT SYSTEMS	8-7
8.16.1	Instrument Duplication	8-7
8.16.2	Inoperative Instruments	8-7
8.16.3	Air Filters	8-7
8.16.4	Desiccant	8-7
8.16.5	Automatic Pilot and Stabilization Units	8-7
8.16.6	Inoperative Automatic Pilot and Stabilization Units	8-7
8.16.7	Instrument Panels	8-7
8.17	PITOT TUBES, ANGLE OF ATTACK AND STATIC VENTS	8-7
8.18	LANDING AND ARRESTING GEAR SYSTEMS	8-7
8.18.1	Landing Gear Functional Check	8-7
8.18.2	Arresting Gear Hooks	8-7
8.18.3	Arresting Gear Dashpot	8-7
8.18.4	Shock Struts	8-7
8.18.5	Axles, Bearings, Brakes, and Wheels	8-8
8.18.6	Landing Gear, Gear Boxes	8-8
8.18.7	Ground Steering Mechanisms	8-9
8.18.8	Locks	8-9
8.18.9	Shimmy Dampers	8-9
8.18.10	Drag Chutes	8-9
8.19	PHOTOGRAPHIC SYSTEMS	8-9
8.20	POWER PLANT SYSTEMS	8-9
8.20.1	Mounts	8-9
8.20.2	Tail Pipes	8-9
8.20.3	Oil Filters and Magnetic Plugs	8-9
8.20.4	Tubing, Hoses, Leads, and Clamps	8-9
8.20.5	Engine Nacelle/Cowling	8-9
8.20.6	Cooling Tubes and Ducts	8-9
8.20.7	Oil Tanks	8-9
8.20.8	Ground Checks	8-9
8.20.9	Leak Checks	8-9
8.20.10	Engine Accessories	8-9
8.20.11	Auxiliary Power Units	8-9
8.20.12	Propeller Anti-Ice Systems	8-9
8.20.13	Propellers (Turbo-Prop Engines)	8-10
8.20.14	Propeller Governors	8-10
8.21	ROTOR AND HUB SYSTEMS	8-10
8.21.1	Helicopter Rotor Blades and Tail Rotor	8-10

TABLE OF CONTENTS - CONTINUED

Chapter		Page
8.21.2	Rotor Hubs	8-10
8.22	SAFETY AND SURVIVAL SYSTEMS	8-10
8.22.1	Canopies	8-10
8.22.2	Ejection Seats	8-10
8.22.3	Fire Extinguishers, Portable	8-10
8.22.4	First Aid Kits	8-10
8.22.5	Life Jackets and Life Rafts	8-10
8.22.6	Emergency Water Landing Survival Equipment	8-10
8.22.7	Personnel Parachutes	8-10
8.22.8	Drag Parachutes and Harness	8-10
8.22.9	Seat Belts, Shoulder Harness, and Inertia Reels (Including Ejection Seats)	8-10
8.22.10	Oxygen Equipment	8-10
8.23	UTILITY SYSTEMS	8-11
8.23.1	Air-conditioning Systems	8-11
8.23.2	Cabin Air Filters and Ducts	8-11
8.23.3	Anti-Icers	8-11
8.23.4	Deicer Boots	8-11
8.23.5	Cabin Air and Pressure Suit Regulators	8-11
8.23.6	Cabin Heaters	8-11
8.23.7	Engine Fire Extinguisher Components	8-11
8.23.8	CAD Actuated Fire Extinguishers	8-11
8.23.9	Lavatory and Toilet Facilities	8-11
8.23.10	Windshield Defrosters	8-11
8.23.11	Windshield Wiper Blades and Arms	8-11
8.24	FLIGHT TEST	8-12
8.25	LOGBOOK ENTRIES	8-12
9	GENERAL DISPOSAL PREPARATION PROCEDURES	9-1
9.1	GENERAL INSTRUCTIONS	9-1
9.1.1	Aircraft and Component Disposal	9-1
9.2	ELECTRICAL AND AVIONIC MATERIAL REMOVAL	9-1
9.3	ACCUMULATOR PRESSURE DEPLETION	9-2
9.4	REFRIGERANT RECOVERY	9-2
9.5	FLUID REMOVAL	9-2
9.6	OXYGEN SYSTEM DEPLETION	9-2
9.7	EMERGENCY SLIDE SYSTEM PRESSURE DEPLETION	9-3
9.8	HALON CONTAINER REMOVAL	9-3
9.9	MERCURY COMPONENT REMOVAL	9-3
9.10	ASBESTOS ABATEMENT	9-3
9.11	RADIOACTIVE MATERIAL REMOVAL	9-4
9.12	LANDING GEAR STRUT AND WHEEL ASSEMBLY PRESSURE DEPLETION	9-4
9.13	ENGINES	9-4
9.14	CLASSIFIED INSPECTION	9-4
9.15	EXPLOSIVE MATERIAL VERIFICATION	9-4
10	GENERAL LIFTING PROCEDURES	10-1
10.1	GENERAL INSTRUCTIONS	10-1
10.2	GENERAL EQUIPMENT	10-1
10.2.1	Slings	10-1
10.2.2	Rigging Hardware	10-1
10.3	MOTORIZED EQUIPMENT	10-1

TABLE OF CONTENTS - CONTINUED

Chapter		Page
10.4	FIXED OVERHEAD CRANES	10-1
10.5	LIFTING OPERATIONS.....	10-2
11	TOOLING STORAGE	11-1
11.1	TOOLING STORAGE	11-1
	APPENDIX A INSPECTION REQUIREMENTS CHECKLIST.....	A-1
A.1	AIRCRAFT STORAGE INSPECTION	A-1

LIST OF ILLUSTRATIONS

Number	Title	Page
1-1	Aircraft Marking Location	1-14
4-1	Tape Application	4-3
4-2	Tape and Barrier Material Application	4-3
4-3	Sealing Openings Greater Than 12 Inches	4-4
4-4	Relief Cuts in Tape	4-4
4-5	Overlapping Tape Application	4-5
4-6	“X” Pattern for Control Surfaces	4-5
4-7	Sealing Diagram Elements (Example)	4-15
7-1	General Chock, Wing and Tail Walker Areas	7-3
7-2	Aircraft Wingspan	7-3
7-3	Chocking with Slats	7-6
7-4	Chocks with Slats Attached	7-6.1
7-5	Tire Inspection Areas	7-7
7-6	Tire Inflation Danger Areas	7-9
7-7	Cable Angular Relationship to Aircraft	7-10
7-8	Cable Mooring Attachment	7-10
10-1	Hand Signals for Crane Operation	10-4

LIST OF TABLES

Number	Title	Page
1-1	List of Materials	1-9
1-2	Aircraft Markings	1-12
2-1	Long Term Storage Preservation Requirements by Storage Types	2-10
2-2	In Storage Inspection Requirements	2-13
3-1	Asset Inspection Requirements	3-2
3-2	Storage Device Inspection Requirements	3-2
4-1	Application Equipment	4-1
4-2	Sealing Materials and Specifications	4-12
7-1	Approved alternate tow bars	7-1
7-2	Storage Aircraft Tire Inspection	7-11
8-1	Strut Leakage Limits	8-8
A-1	Preparation	A-1
A-2	Fuselage Inspection	A-1
A-3	Crew Station	A-2
A-4	Cargo/Passenger Compartment	A-2
A-5	Landing Gear	A-3
A-6	Propeller(s)	A-3
A-7	Helicopter Rotor System	A-3
A-8	Engine(s)	A-3

INTRODUCTION

1 PURPOSE.

The purpose of this manual is to provide guidance for preservation, inspection during storage, reclamation, depreservation, ferry flight and preparation for disposal, for aircraft, engines and components stored at the 309 Aerospace Maintenance and Regeneration Group (AMARG). The term aircraft as used in this manual includes fixed wing, rotary wing and unmanned aerial vehicles.

2 SCOPE.

This manual provides essential information to personnel on processes and procedures used to properly store assets in a desert environment. AMARG Desert Operations are those maintenance tasks that are performed at AMARG on assets placed in a storage maintenance production category. Technical Order (TO) 00-20-1 defines the proper use of technical data while performing AMARG Desert Operations. Mechanics performing Desert Operations must follow applicable technical guidance as closely as possible but may omit steps when those steps cannot be followed due to assets being stored in a non-standard condition. Assets sent to AMARG are usually placed into long term storage. Processes used to place assets into storage results in systems being disabled, preserved, and non-functional. Aircraft may be sealed, preventing access to aircraft external and internal areas such as cockpits, avionics bays, engine intakes and exhaust etc. Aircraft are considered to be in storage after the fuel system and engines are preserved on initial storage induction. This manual is intended to augment and supplement other manuals and technical orders. This manual should be used as an aid in establishing AMARG Desert Operations training. This manual's primary audience are individuals assigned to AMARG. Personnel will not perform AMARG Desert Operations or tasks within this manual unless the proper training has been provided and documented in the required training system.

3 APPLICATION.

This manual is applicable only to aircraft, engines, components and other major end items placed in a storage maintenance production category at AMARG. This manual may be used at other locations to perform AMARG processes and procedures with owning agency approval. Instructions contained in other related specific directives will be used in conjunction with this manual. When conflicts exists between applicable technical data and this manual, this manual shall take precedence except under the following conditions:

- When the standardized procedures of this manual may damage equipment.
- When detailed procedures are specific to the aircraft or engine model and specified in the applicable Work Load Agreement (WLA)/Statement of Work (SOW).

4 COMPLIANCE TERMINOLOGY.

For the purpose of this technical order, the following definitions apply:

- The use of "shall", "will" or "must" expresses a mandatory provision.
- The use of "should" or "may" express non-mandatory provisions.

5 APPLICABLE TECHNICAL DATA.

This manual cannot include all possible technical data references required for the large variety of stored aircraft at AMARG. Many tasks must be accomplished using the applicable technical data for the aircraft. Examples of applicable technical data are Technical Orders, Maintenance Instruction Manuals, Technical Manuals, Electronic Technical Data, Process Orders, Engineering Orders, Requests for Engineering Instructions, 107/202 dispositions, Special Packaging Instructions (SPI), approved drawings, Sealing Diagrams, and Module Worksheets. Deviations from applicable technical data will be accomplished per owning agency guidelines.

- This manual uses the following notation: (Applicable technical data.) placed after a process step.
- This notation indicates the step will be accomplished using the applicable technical data for the aircraft, engine or component.
- Review and observe all Warnings, Cautions and Notes in the applicable technical data.

NOTE

Unless otherwise specified, all aircraft will be processed using common procedures except as noted under appropriate section headings.

6 DEVIATIONS AND CHANGES.

Aircraft and engines shall be prepared and maintained in accordance with the requirements for the type of preservation specified by the owning agency. The standard processes for each type of preservation are the minimum requirements for storage and shall be completed. Any deviations to the standard processes will be negotiated between AMARG and the owning agency. TO 1-1-686/Army TM 55-1500-331-34/NAVAIR 15-01-4 is a tri-service manual. Individual service contacts are as follows.

6.1 Air Force Equipment or Procedures. Contact the Weapons System Program Manager (PM).

6.2 Army Equipment or Procedures. Contact Aviation and Missile Command (AMCOM), Red Stone Arsenal.

6.3 Navy Equipment or Procedures. Contact NAVAL SUPPLY SYSTEMS COMMAND WEAPON SYSTEMS SUPPORT DET FIELD SUPPORT OFFICE, Tucson, AZ.

6.4 AMARG Procedures. Contact the AMARG Technical Content Manager (TCM).

6.5 Change Reporting. Publication changes will be accomplished using the service specific engineering process. Changes will be coordinated with each responsible organization.

7 PURPOSE OF PRESERVATION.

Preservation includes servicing or deactivation of systems, corrosion detection, repair and prevention, and coating and sealing an asset for storage. The purpose for preservation and storage of aircraft, engines and related components is three fold.

- Prevent or reduce the rate of corrosion of metallic parts.
- Reduce the rate of deterioration of non-metallic parts.
- Minimize physical damage to aircraft, engines, and related components during handling, storage, and shipment.

8 AIRCRAFT STORAGE TYPES.

This manual includes storage instructions for five types of aircraft storage:

NOTE

- Installed engines and removed engines obligated to an aircraft are considered part of the aircraft and are in the same type storage category as the aircraft.
- Removed propeller and helicopter rotor blades are considered part of the aircraft and retain the same type storage category as the aircraft.

8.1 Type 1000 Storage. Type 1000 storage procedures are intended to maintain the functional and material integrity of aircraft systems and components for extended periods of time. Type 1000 storage is the only storage type with a recurring preservation requirement.

8.2 Type 1500 Storage. Type 1500 storage eliminates only the recurring preservation requirement but does not alter any other initial induction requirement for Type 1000 storage. Type 1500 can be indefinite, but deterioration will be more than expected for Type 1000 storage.

8.3 Type 2000 Storage. Type 2000 storage procedures are intended to preserve an aerospace vehicle with a minimized expenditure of resources while maintaining components and parts in a reclaimable condition.

8.4 Type 3000 Storage. Type 3000, temporary storage applies to aircraft maintained in active flying status. Type 3000 storage requirements will be coordinated between AMARG and the owning agency per Workload/Inter-Service Support Agreement and Statement of Work.

8.5 Type 4000 Storage. Type 4000 storage procedures are used for economical storage with limited preservation of airframe and engines. Assets will be protected with barrier systems. Type 4000 assets may have parts reclaimed prior to disposal. AMARG will place assets into disposal preparation status once the owning agency submits the proper documentation (e.g. Air Force Form 913, Aerospace Vehicle Project Action). Owing agency may request preservation of engines.

8.6 Type Storage Changes. All changes to aircraft or engine storage types will be accomplished using each owning agency regulatory guidance and applicable engineering process.

NOTE

Removal of any components, to include Quick Engine Change Kit (QEC) items from the engine are not authorized without the approval of the appropriate engine program office.

9 UNINSTALLED ENGINE STORAGE TYPES

This manual includes storage instructions for five types of engine storage. Owing agency will specify engine storage type.

9.1 Type 1000 Storage. Type 1000 storage procedures are intended to maintain the functional and material integrity of engine systems and components for extended periods of time. Type 1000 storage is the only storage type with a recurring preservation requirement. The owning agency will specify recurring preservation requirements.

9.2 Type 1500 Storage. Type 1500 storage eliminates only the recurring preservation requirement but does not alter any other initial induction requirement for Type 1000 storage. Type 1500 can be indefinite, but deterioration will be more than expected for Type 1000 storage.

9.3 Type 2000 Storage. Type 2000 storage procedures are intended to preserve an engine with a minimized expenditure of resources while maintaining components and parts in a reclaimable condition.

9.4 Type 4000 Storage. Type 4000 storage procedures are used for economical storage with no preservation of the engines. Assets will be protected with barrier systems. Type 4000 assets may have parts reclaimed prior to disposal. AMARG will place assets into disposal preparation status once the owning agency submits the proper documentation to the AMARG engine manager. Owing agency may request initial storage induction preservation of engines.

9.5 Type 4500 Storage, (United States Air Force (USAF) only). Type 4500 storage is for engines approved for disposal.

9.6 USAF Storage Categories. Uninstalled (USAF) engines will be designated by the storage categories listed in Table 1.

Table 1. Engine Storage Categories

Type Storage	Storage Category
1000	C

Table 1. Engine Storage Categories - Continued

Type Storage	Storage Category
1500	Inactive Hold
2000	Inactive Reclamation
4000	Inactive, Awaiting Disposal
4500	Inactive, Approved for Disposal

9.7 Comprehensive Engine Management System (CEMS) Storage Codes (USAF only). The following codes listed in Table 2. will be used in CEMS as special status codes for AMARG stored engines.

Table 2. CEMS Codes

Type Storage	Inactive Engines	Drone Assets
1000	S10	D10/DRO
1500	S15	D15
2000	S20	D20
4000	S40	D40
4500	S45	S45

10 PRESERVATION PROCESSING.

NOTE

All references to days in this technical order are calendar days.

10.1 Processing Time. Aircraft and uninstalled engine or propeller storage induction and preservation procedures will be completed within 60 days of receipt. A maximum of 15 additional days are permissible for aircraft preservation if adverse weather conditions occur during the preservation process.

10.1.1 Aircraft defueling procedures and engine preservation procedures will be completed no later than 19 days after arrival at AMARG.

10.1.2 If preservation procedures cannot be completed within the specified time frame of 60 days, AMARG will submit the appropriate documentation (e.g. Air Force Form 202) to the owning agency requesting guidance and/or an extension.

11 RECURRING PRESERVATION PROCEDURES.

NOTE

Uninstalled engine recurring preservation requirements will be specified by owning agency.

11.1 Type 1000 Storage. Only Type 1000 storage assets have recurring preservation requirements. Recurring preservation consists of depreservation per Chapter 6 and completing Type 1000 preservation requirements per Chapter 2. Recurring preservation interval shall be 48 months plus or minus 3 months or per program directed requirements.

11.2 Recurring Preservation Time. Recurring preservation of aircraft, engines, or components, from initiation to final sealing, shall be accomplished within 60 days. A maximum of 15 additional days are permissible for aircraft preservation if adverse weather conditions occur during the preservation process.

11.3 Aircraft with Removed Parts. Aircraft that have had parts removed during the storage period may not be functionally capable of a complete recurring preservation of all systems. If this condition is identified, contact the owning agency cognizant engineering authority. The owning agency cognizant engineering authority will furnish AMARG detailed disposition instructions within 15 days.

11.4 Sealing Diagram Changes. Changes to the applicable aircraft Sealing Diagram will be incorporated during recurring preservation unless directed by the owning agency.

12 RECORDS.

The date of aircraft, engine or component arrival to AMARG, date of initial and recurring preservation, in storage inspection dates, departure date and components reclaimed from aircraft and engines while at AMARG will be inputted into the AMARG Business System (ABS). When an asset is transferred, pertinent data requested by the owning agency will be sent with the asset.

13 REGENERATION/FERRY FLIGHT.

13.1 Air Force, Army and Other Agency Aircraft. Air Force, Army and other agency aircraft shall be prepared for regeneration or one time ferry flight in accordance with applicable technical data and owning agency Statement of Work. Contact appropriate Engine System Program Office for specific engine regeneration guidance for installed engines.

13.2 Navy Aircraft. Navy aircraft shall be prepared for regeneration or one time ferry flight per Chapter 8. Specific tasks will be performed in accordance with the applicable technical data for the aircraft.

14 ABBREVIATIONS.

All abbreviations used in this manual are shown in the list of abbreviations below. Standard abbreviations are in accordance with ASME Y14.38, Abbreviations and Acronyms for Use on Drawings and Related Documents.

°F	degrees Fahrenheit
ABS	AMARG Business System
AF	Air Force
AFTO	Air Force Technical Order
AGE	Aerospace Ground Equipment
AMARG	Aerospace Maintenance and Regeneration Group
AMCOM	Aviation and Missile Command
APU	Auxiliary Power Unit
CAD	Cartridge Actuated Device
CEMS	Comprehensive Engine Management System
CPC	Corrosion Preventative Compound
CRT	Cathode Ray Tubes
DLA	Defense Logistics Agency
DoD	Department of Defense
DTA	Detonation Transfer Assembly
ESDS	Electrostatic Discharge Sensitive
ETIMS	Enhanced Technical Information Management System
GSA	General Services Administration
GOX	Gaseous Oxygen
HAZMAT	Hazardous Material
HCI	Hardness Critical Items
IFF	Identify Friend or Foe
JSA	Job Safety Analysis
LEL	Lower Explosive Limit
LOX	Liquid Oxygen
mg	milligram
MWL	Maximum Wear Limit
OSHA	Occupational Safety and Health Administration
PCB	polychlorinated biphenyl

PM	Program Manager
PN	Part Number
POX	Portable Oxygen
PPE	Personal Protective Equipment
PSI	Pound-force per Square Inch
QEC	Quick Engine Change Kit
RM	Risk Management
rpm	revolution per minute
SDS	Safety Data Sheet
SIF	Selective Identification Feature
SMDC	Shielded Mild Detonating Cord
SOW	Statement of Work
SPI	Special Packaging Instructions
TCM	Technical Content Manager
TCTO	Time Compliance Technical Order
TO	Technical Order
TOMA	Technical Order Management Agency
UAB	Underwater Acoustic Beacon
USAF	United States Air Force
WLA	Work Load Agreement

15 RELATED PUBLICATIONS.

NOTE

When searching TO numbers in the Enhanced Technical Information Management System (ETIMS) catalog, please use the wildcard (*) after typing in the TO number. Many TOs are not available in paper format, (i.e., digital (WA-1) or Compact Disk (CD-1)). This ensures TOs in all media formats will populate the search.

The following publications contain information in support of this technical manual.

List of Related Publications

Number	Title
ASME Y14.38	Abbreviations and Acronyms for Use on Drawings and Related Documents
DODI 5330.03_AFI 33-395	Defense Logistics Agency (DLA) Document Services
TO 00-5-1	AF Technical Order System
TO 00-20-1	Aerospace Equipment Maintenance Inspection, Documentation, Policies, and Procedures
TO 00-25-195	AF Technical Order System Source, Maintenance, and Recoverability Coding of Air Force Weapons, Systems, and Equipments
TO 00-25-234	General Shop Practice Requirements for the Repair, Maintenance, and Test of Electrical Equipment
TO 00-80C-1	Crashed, Damaged, Disabled Aircraft Recovery Manual
TO 1-1-691	Cleaning and Corrosion Prevention and Control, Aerospace and Non-Aerospace Equipment
TO 4T-1-3	Inspection, Maintenance Instructions, Storage and Disposition of Aircraft Tires and Inner Tubes
TO 32A20-3-80-1	Tire Inflator Assembly Kit

16 RECORD OF APPLICABLE TIME COMPLIANCE TECHNICAL ORDERS (TCTOS).

List of Time Compliance Technical Orders

TCTO Number	TCTO Title	TCTO Date
None		

17  HARDNESS CRITICAL ITEMS (HCI).



The HCI symbol () establishes special requirements limiting changes and substitutions and that the specific parts listed must be used to ensure hardness is not degraded.

If included, items with nuclear survivability requirements are marked with the HCI symbol (). All changes to, or proposed substitutions of, HCIs must be approved by the acquiring activity.

18  ELECTROSTATIC DISCHARGE SENSITIVE (ESDS) ITEMS.



All ESDS parts shall be handled in accordance with the ESDS device handling procedures in TO 00-25-234.

If included, items containing ESDS parts are marked with the ESDS symbol ()

19 IMPROVEMENT REPORTS.

Recommended changes to this manual shall be submitted in accordance with TO 00-5-1.

SAFETY SUMMARY

1 GENERAL SAFETY INSTRUCTIONS.

This manual describes physical and/or chemical processes which may cause injury or death to personnel, or damage to equipment, if not properly followed. This safety summary includes general safety precautions and instructions that must be understood and applied during operation and maintenance to ensure personnel safety and protection of equipment. Prior to performing any specific task, the WARNINGS, CAUTIONS, and NOTES included in that task shall be reviewed and understood.

2 WARNINGS, CAUTIONS, AND NOTES.

WARNINGS and CAUTIONS are used in this manual to highlight operating or maintenance procedures, practices, conditions, or statements which are considered essential to protection of personnel (WARNING) or equipment (CAUTION). WARNINGS and CAUTIONS immediately precede the step or procedure to which they apply. WARNINGS and CAUTIONS consist of four parts: heading (WARNING, CAUTION, or icon), a statement of the hazard, minimum precautions, and possible results if disregarded. NOTES are used in this manual to highlight operating or maintenance procedures, practices, conditions, or statements which are not essential to protection of personnel or equipment. NOTES may precede or follow the step or procedure, depending upon the information to be highlighted. The headings used and their definitions are as follows:

WARNING

Highlights an essential operating or maintenance procedure, practice, condition, statement, etc. Failure to comply could result in injury to, or death of, personnel or long term health hazards.

CAUTION

Highlights an essential operating or maintenance procedure, practice, condition, statement, etc. Failure to comply could result in damage to, or destruction of, equipment or loss of mission effectiveness.

NOTE

Highlights an essential operating or maintenance procedure, condition, or statement.

3 HAZARDOUS MATERIALS WARNINGS.

Hazardous Materials Warnings are provided through use of the following Hazard Symbols. Consult the HAZARDOUS MATERIALS DESCRIPTION or Safety Data Sheet (SDS) (formerly MSDS) (Occupational Safety and Health Administration (OSHA) Form 20 or equivalent) for specific information on hazards, effects, and protective equipment requirements. If you do not have an SDS for the material involved, contact your supervisor, or the base Safety or Bioenvironmental Engineering Offices.

3.1 Hazardous Materials Icons. The following icons are used throughout this Air Force technical manual to indicate the use of hazardous materials:



The abstract symbol bug shows that a material may contain bacteria or viruses that present a danger to your life or health.



The symbol of a human figure in a cloud shows that the material gives off vapors that are a danger to life or health.



The symbol of drops of liquid onto a hand shows that the material will cause burns or irritation of skin and tissue.



The rapidly expanding symbol shows that the material may explode if subjected to high temperatures, sources of ignition or high pressure.



The symbol of a person wearing goggles shows that the material will injure eyes.



The symbol of a flame shows that the material can ignite and burn.



The symbol of a skull and crossbones shows that the material is poisonous or a danger to life.



The symbol of a liquid entering the mouth shows that eating or drinking this material can cause a health hazard.



The symbol of three circular wedges shows that radioactive energy is emitted which can injure tissue and organs.



The hand symbol shows a material that can irritate the skin or enter the body through the skin and cause a health hazard.

3.2 Hazardous Materials Description. The following detailed HAZMAT warnings pertain to materials or substances used in connection with procedures called out or described in this technical manual. Use these advisory warnings and their associated precautions in conjunction with the current SDS for each material or substance. If there is conflict between this safety summary and the SDS, the SDS takes precedence.



MIL-PRF-85570, CLEANING COMPOUND, AIRCRAFT

1

Aircraft Cleaning Compound is a skin and eye irritant. Avoid skin and eye contact. Use in well-ventilated areas. Rubber gloves and splash proof goggles are required. Wash hands thoroughly after each use. Avoid breathing vapors. Store in cool, dry, well-ventilated and low fire risk area. Avoid contact with strong acids or oxidizing agents.



MIL-PRF-680, SOLVENT, DEGREASING, TYPE II AND III

2

Degreasing solvent is an eye, skin, and respiratory tract irritant. Use only in a well ventilated area. Use explosion proof equipment. Nitrile gloves, splash proof goggles and impervious clothing is required. Wash thoroughly after handling and before eating or smoking. Keep away from heat and open flames. Store in a clean, cool well ventilated area away from ignition sources and oxidizing agents.



MIL-D-16791, DETERGENT, TYPE I, NON-IONIC

3

Non-ionic detergent, Type I, is an eye irritant. Avoid contact with eyes. Chemical resistant goggles required. Store away from heat sources. Avoid contact with strong oxidizing or reducing agents. Material is corrosive to copper and brass on long storage.



A-A-2787, ENAMEL (AEROSOL, LOW VOC)

4

Enamel (Aerosol, Low VOC) is a skin, eye and respiratory tract irritant. Use only in well-ventilated areas or use respirator protection. Wear chemical resistant gloves, safety glasses with side shields or chemical goggles. Wash hands thoroughly after handling. Do not expose to temperatures over 120 °F. Keep away from heat, sparks and flame.



A-A-208, INK, MARKING, STENCIL

5

Marking ink is extremely flammable and a skin, eye and respiratory tract irritant. Use only in well-ventilated area. Wear plastic, rubber or neoprene gloves, and chemical safety goggles when spraying. Do not breathe vapors. Wash hands before eating. Explosion hazard exist when spray cans are heated. Place leaking containers outdoors, in an open container, away from sources of ignition. Store in a cool, well ventilated areas away from sources of ignition. Do not store above 120 °F.



MIL-PRF-16173, COMPOUND, CORROSION PREVENTIVE

7

Corrosion Preventive Compound is an eye, skin, and respiratory tract irritant. May be flammable. Protect arms and legs from chemicals. Use only in a well ventilated area. Keep away from heat and open flames. Store in a clean, cool well ventilated area.



MIL-PRF-6081, LUBRICATING OIL, JET ENGINE

8

Lubricating oil is a mild skin and eye irritant. Use impervious gloves and goggles or face shield. Do not store near heat, open flames or sources of ignition. Use adequate ventilation.

AIR FORCE TO 1-1-686
ARMY TM 55-1500-331-34
NAVY (NAVAIR) 15-01-4



MIL-PRF-87937, CLEANING COMPOUND, AIRCRAFT, TYPE II, IV, AND V

10

Aircraft cleaning compound is a skin, eye and respiratory tract irritant. Avoid breathing vapors. Avoid skin and eye contact. Rubber or latex gloves and safety glasses with side shields or goggles are required. Wash thoroughly after handling. Use only in well-ventilated areas.



MIL-PRF-81322, GREASE, AIRCRAFT GENERAL PURPOSE

11

General Purpose Aircraft Grease is a minor skin and eye irritant. Use only in a well ventilated area. Safety glasses and gloves are required. Wash hands with soap and water thoroughly after use. Store in a clean, cool well ventilated area away from ignition sources.



MIL-DTL-85054, COMPOUND, CORROSION PREVENTIVE

12

Corrosion Preventive Compound, is toxic, flammable and a skin, eye and respiratory tract irritant. Rubber gloves and safety goggles are required. Avoid skin and eye contact. Avoid breathing vapors. Use in well-ventilated area. Keep away from heat, sparks, and flame.



MIL-PRF-6799, COATING, SPRAYABLE, STRIPPABLE, PROTECTIVE, WATER EMULSION

14

Sprayable, strippable coating is a skin, eye, and respiratory tract irritant. Use dust mask or respirator if the concentration is high. Wear rubber, neoprene or nitrile gloves, safety-perforated side shields, or goggles. An apron is recommended to avoid skin contact. Wash hands after handling and before eating, drinking, or using the washroom. MIL-PRF-6799 is flammable, store away for ignition sources.



TT-I-735, ISOPROPYL ALCOHOL

15

Isopropyl Alcohol, is flammable and a skin, eye, and respiratory tract irritant. In case of ingestion seek medical attention immediately. Avoid contact with eyes, skin or clothing. Use only in a well ventilated area. Neoprene gloves, safety goggles, coveralls and boots are required. Wash thoroughly after handling. Avoid breathing vapor or mist. Store in a clean, cool well ventilated area away from ignition sources.



P-P-560, POLISH, PLASTIC

16

Plastic Polish is a mild skin, eye, and respiratory tract irritant. Wear impermeable gloves and safety glasses or goggles for protection. Do not use near heat or flames. Store away from heat and flame. Wash hands after handling and before eating, drinking or smoking.



WAX, AIRCRAFT, WATERPROOF, SOLVENT TYPE, (FORMERLY MIL-W-18723), COMMERCIAL PURCHASE

17

Aircraft waterproof wax (Formerly MIL-W-18723) should be handled as a combustible material. Avoid storage near open flames or sparks.



MIL-D-3464, DESICCANT, ACTIVATED, BAGGED

18

MIL-D-3464, is an eye, nose and throat irritant. May also cause skin, respiratory tract and GI tract irritant. Wash hands after handling and before eating, drinking or smoking. Launder contaminated clothing before reuse. Store in dry area. Avoid moisture and keep dry.



A-A-59503, NITROGEN

19

Nitrogen is a simple asphyxiant. Oxygen levels should be maintained at greater than 18 molar percent at normal atmospheric pressure which is equivalent to a partial pressure of 135 MM HG. A positive pressure air line with mask or self-contained breathing apparatus should be available for emergency use. Local and mechanical exhaust to provide adequate ventilation. Wear gloves, safety goggles, and safety shoes. Store in cool, dry well ventilated area away from heavily trafficked areas and emergency exits.

4 SAFETY PRECAUTIONS.

The following safety precautions shall be observed while performing procedures in this manual.

- Dangerous voltages are present at system connectors. Ensure power is OFF prior to connecting or disconnecting cables.
- Do not wear metal frame glasses, rings, watches, or other metal jewelry while working on electronic equipment.
- Some cleaning materials specified herein are flammable and/or toxic. Keep away from open flame or other ignition sources. Provide adequate ventilation and avoid skin/eye exposure.
- Cleaning with compressed air can create airborne particles that may enter eyes or penetrate skin. Pressure shall not exceed 30 Pound-force per Square Inch, Gauge (PSIG). Wear goggles. Do not direct compressed air against skin.

5 AMARG SPECIFIC SAFETY PRECAUTIONS AND MATERIAL WARNINGS.

WARNING

AMARG storage, reclamation and disposal actions are performed in the desert environment. Storage assets are not in operational condition. Assets may have structural components removed, may be supported by wooden modules, may have insect or wildlife intrusion, may be located in erosion zones, may have weathered tires and non-operational components and have other potential hazards that are not present in operational aircraft maintenance environments. The following safety precautions shall be observed while performing procedures in this manual. These are precautions that personnel must understand and apply during all phases of desert operations. Failure to observe these warnings may result in death or injury to personnel.

5.1 Center of Gravity Precautions. The center of gravity of storage assets will change due to component removal, structural cuts, ballast installation or removal, and other factors. The center of gravity of a storage asset may not be in the same location as the center of gravity of an operational aircraft. Desert Operations actions on an asset with an unknown center of gravity may result in the asset tipping or falling. Prior to performing any lifting or jacking of an asset, assess the possible center of gravity changes to the asset. Prior to performing any action that may change the center of gravity of an asset, such as component removal or aircraft structural cuts, assess the possible center of gravity changes to the asset. Support the asset prior to performing actions that may change the center of gravity of the asset. Contact AMARG Engineering or owning agency engineering services for assistance evaluating the center of gravity or center of gravity changes.

5.2 Storage Tire Precautions. Tires on desert stored aircraft are not suitable for operational use. Tires will weather over time. Deflated tires require inspection prior to inflation. Tires may require replacement. Inflation of desert stored tires may result in tire failure. Tires on storage aircraft may catastrophically fail due to deteriorated condition and increased heat and stress during aircraft towing. Tire failure may result in flying tire debris. Personnel assigned as chock walkers, wing walkers, tail walkers, tow team members, and personnel inflating tires, should position themselves aft of wheel and tire assemblies whenever possible during towing and inflation operations.

NOTE

The following general HAZMAT warnings pertain to material or substances referenced in procedures described in this technical manual. This manual does not direct the use of these materials. These materials are present on many storage aircraft or components. Applicable technical data for the aircraft may provide more detailed material hazard information. The following general HAZMAT warnings are used to alert technicians to these materials on aircraft.

5.3 Radioactive Components.



RADIOACTIVE COMPONENTS

22

This symbol and notice alerts technicians that radioactive components may be present on the aircraft. Refer to the applicable technical data for the aircraft for specific information.

5.3.1 Radiological Precautions. Asset disposal actions require the removal of radioactive components prior to final disposal. Only identified, trained and certified AMARG personnel will perform radiological hazard identification and removal actions. Consult DOD, USAF, AMARG, federal, state and local requirements and applicable technical data for radiological component handling procedures and material warnings. Personnel will consult the work center Industrial Hygiene Survey and Occupational Safety and Health (OSHA) regulations for Personal Protective Equipment (PPE) requirements.

5.4 Halon Fire Extinguisher Cylinders.



HALON FIRE EXTINGUISHER CYLINDERS

23

This symbol and notice alerts technicians that onboard fire extinguishing system components may be present on aircraft. Typical system components may include pressurized Halon fire extinguisher cylinders with explosive squibs. Refer to the applicable technical data for the aircraft for specific information.

5.4.1 Halon Cylinder Precautions. Asset disposal actions require the removal of halon cylinders and explosive squibs prior to final disposal. Only identified, trained and certified AMARG personnel will perform halon cylinder and explosive squib hazard identification and removal actions. Halon cylinders will not be depleted to atmosphere. Consult USAF, AMARG, and applicable technical data for Halon cylinder and explosive squib handling procedures and material warnings.

5.5 Liquid Refrigerant.



LIQUID REFRIGERANT

9

This symbol and notice alerts technicians that air-conditioning systems may be present on aircraft. Onboard air-conditioning systems may contain liquid refrigerants. Refer to the applicable technical data for the aircraft for specific information.

5.5.1 Refrigerant Recovery Precautions. Asset storage preparation and disposal actions require the recovery of refrigerant from air conditioning systems. Only identified, trained and certified AMARG personnel will perform refrigerant recovery actions. Refrigerants will not be vented to atmosphere. Consult USAF, AMARG, federal, state and local requirements and applicable technical data for refrigerant recovery and handling procedures and material warnings. Personnel will consult the work center Industrial Hygiene Survey and OSHA regulations for PPE requirements.

5.6 Asbestos.



ASBESTOS

20

This symbol and notice alerts technicians that asbestos material may be present on the aircraft. Refer to the applicable technical data for the aircraft for specific information.

5.6.1 Asbestos Precautions. Asset disposal actions require the identification and abatement of asbestos prior to final disposal. Only identified, trained and certified AMARG personnel will perform asbestos identification and abatement actions. Consult DOD, USAF, AMARG, federal, state and local requirements and applicable technical data for asbestos abatement procedures and material warnings. Personnel will consult the work center Industrial Hygiene Survey and OSHA regulations for PPE requirements.

5.7 Detonation Transfer Assembly (DTA)/Shielded Mild Detonation Cord (SMDC).



DETONATION TRANSFER ASSEMBLY (DTA)/SHIELDED MILD DETONATION CORD (SMDC)

6

This symbol and notice alerts technicians that DTA/SMDC components may be present on aircraft. DTA/SMDC components are used in canopy jettison and ejection systems. Refer to the applicable technical data for the aircraft for specific information.

5.8 Mercury.



MERCURY

21

This symbol and notice alerts technicians that mercury may be present in some components on the aircraft. Refer to the applicable technical data for the aircraft for specific information.

5.9 Explosive Components.



EXPLOSIVE COMPONENTS

24

This symbol and notice alerts technicians that explosive components may be present on aircraft. Explosive components may include fire extinguisher squibs, ordnance, and other explosives. Each aircraft may have different explosive components. Refer to the applicable technical data for the aircraft for specific information.

5.10 MIL-PRF-85285, Topcoat.



MIL-PRF-85285, TOPCOAT

13

This symbol and notice alerts technicians that MIL-PRF-85285 Topcoat will be applied to the aircraft. Application of the MIL-PRF-85285 Topcoat will be in accordance with the applicable technical data. Refer to the applicable technical data for the aircraft for specific information.

CHAPTER 1 GENERAL INFORMATION

1.1 GENERAL.

This chapter contains the material listing as well as general processes for cleaning, inspection, marking and other common Aerospace Maintenance and Regeneration Group (AMARG) processes.

1.1.1 Material Listing. Common materials used at AMARG are listed in Table 1-1.

1.2 CLEANING.

Aircraft and components will be cleaned per Technical Order (TO) 1-1-691, NAVAIR 01-1A-509-2/Army TM 55-1500-243-23 and this manual.

1.3 COMPONENT CLEANING.

1.3.1 Vacuum Cleaning. Vacuum cleaning may be used to remove loose dust, dirt and particles from cockpits, interior compartments, radome interiors, electronics racks or compartments, armament compartments, photographic equipment, camera system components, windows, etc.

1.3.2 Detergent Hand Cleaning.



MIL-PRF-85570, CLEANING COMPOUND, AIRCRAFT

1

Hand cleaning with MIL-PRF-85570, Type II, per Paragraph 1.4. may be used for general cleaning of components.

1.3.3 Solvent Hand Cleaning.



MIL-PRF-680, SOLVENT, DEGREASING, TYPE II AND III

2

Hand cleaning with MIL-PRF-680, Type II, per Paragraph 1.4.6. may be used to remove soils from transmission and drive systems, camera mounts, rotor and hub systems.

1.3.4 Canopy Seals and Mating Surfaces.



MIL-PRF-16791, DETERGENT, TYPE I, NON-IONIC

3

Clean using a water solution of general purpose detergent, MIL-D-16791 on wiping cloths. Rinse with water and dry using wiping cloths.

1.3.5 Special Cleaning Requirements. The following items have special cleaning requirements: exposed piston surfaces of landing gear, exposed piston surfaces of hydraulic actuators, wheels, brakes, avionics, oxygen lines, optical glass, acrylic and plastic surfaces. Clean the listed items in accordance with TO 1-1-691, NAVAIR 01-1A-509-2/Army TM 55-1500-243-23.

1.4 HAND CLEANING METHOD.

Hand cleaning may be used on aircraft, aircraft installed components and removed components, except as listed above, to remove the following types of soils. Mix the concentration of cleaner per Paragraph 1.4.4.

1.4.1 Light Soil. Dirt, dust, mud, salt, loose soot. External surfaces of avionics equipment will only be cleaned with the cleaner concentration for light soil.

1.4.2 Moderate Soil. Hydraulic fluid, lube oils, light preservatives.

1.4.3 Heavy Soil. Heated dried oils, aged preservatives, grease, gun blast, exhaust deposits.

1.4.4 Cleaning Compound.



MIL-PRF-85570, CLEANING COMPOUND, AIRCRAFT

1

Mix Cleaning Compound as follows:

Light soils	Mix 1 part MIL-PRF-85570, Type II, with 14 parts water.
Moderate soils	Mix 1 part MIL-PRF-85570, Type II, with 9 parts water.
Heavy soils	Mix 1 part MIL-PRF-85570, Type II, with 4 parts water.

1.4.5 Hand Cleaning. Hand Cleaning Procedure:

- a. Determine the type of soil.
- b. Mix cleaning compound for the type of soil.
- c. Wipe or brush cleaning mixture on soiled surface.
- d. Wipe or agitate the component surface with a wet cloth or brush.
- e. Wipe the area with a cloth wetted with clean water.
- f. Dry the area with a clean dry cloth.
- g. Repeat the above steps as needed to clean surfaces.
- h. If the initial concentration of cleaner does not effectively clean the area, mix the next highest concentration and repeat the cleaning process.



MIL-PRF-680, SOLVENT, DEGREASING, TYPE II AND III

2

- i. If the highest concentration of cleaner does not effectively clean the area, clean with MIL-PRF-680, Type II, per Paragraph 1.4.6.

NOTE

TO 1-1-691, NAVAIR 01-1A-509-2/Army TM 55-1500-243-23 lists acceptable alternatives to MIL-PRF-680, Type II. Refer to TO 1-1-691, NAVAIR 01-1A-509-2/Army TM 55-1500-243-23 for use instructions and material warnings for acceptable alternate materials.

1.4.6 MIL-PRF-680 Cleaning Procedure.



MIL-PRF-680, SOLVENT, DEGREASING, TYPE II AND III

2

- a. Wipe with saturated cloth or brush MIL-PRF-680, Type II, on soiled area.
- b. Wipe or agitate the component surface with a cloth or brush.
- c. Clean area with the light soil concentration hand cleaning procedure and wipe dry with a dry cloth.

NOTE

The following inspection guidance may be used when no technical data specific inspection guidance is provided.

1.5 GENERAL VISUAL INSPECTION.

1.5.1 Inspection Aids. Inspection aids may include flashlights, mirrors and magnifying glass (minimum 2x power).

1.5.2 Area Preparation. Clean inspection area prior to performing inspection.

1.5.3 Visual Inspection. Perform general visual inspection per the following:

- a. Inspect the visible areas for foreign objects, missing fasteners and obvious damage.
- b. Inspect the visible areas for surface cracks. Typical crack areas may include, but are not limited to flanges, webs, stiffeners, flange edges, and flange radius. A crack may appear as a relatively straight, well defined line with sharp ends.
- c. Inspect the visible areas for corrosion. Corrosion may appear as a discoloration of the surface material, flaking material or raised or bubbled paint surfaces.
- d. Inspect the visible areas for dents. Dents are localized displacements of a surface.

1.6 AMARG AEROSPACE ASSET MARKING.

Asset markings are applied using aerosol spray paint, stencil ink or tape. Markings may be used to identify the asset, identify the status of the asset, identify actions completed on the asset, or identify defective components on an asset. Tape may be used to temporarily mark assets. Tape marking will be removed when the temporary marking is no longer required. Stencils will be used to apply markings on all AMARG assets.

- a. Apply markings per Table 1-1. and Figure 1-1.



A-A-2787, ENAMEL (AEROSOL, LOW VOC)

4



A-A-208, INK, MARKING, STENCIL

5

- b. Apply Aerosol paint, A-A-2787, or stencil ink, A-A-208, per manufacturer's instructions.
- c. When applying a marking over an existing marking, paint over the original marking using aerosol paint, A-A-2787, and reapply new marking.

1.7 AMARG SUPPORT FIXTURES.

AMARG is authorized to use wooden support fixtures (Modules) to stabilize and support assets in storage. Module construction and placement will be performed per AMARG Process Orders and Module worksheets.

1.8 AMARG DESERT OPERATIONS PROCEDURES.

1.8.1 Safe for AMARG Desert Operations. Safe for AMARG Desert Operations can be performed on storage assets (e.g. aircraft, aircraft components, and stored equipment etc.). Accomplishment of Safe for AMARG Desert Operations does not require written documentation.

- a. Inspect support modules for serviceability if installed.
- (1) Inspect modules for stability and position (tipping). The entire module base should be in contact with the ground.
 - (2) Inspect plywood for dry rotting, cracking, delamination and separation from structure.
 - (3) Inspect module support beams for cracking and separation.
- b. Verify landing gear for down and locked condition and installed lock pins if asset is supported by landing gear.

NOTE

AV-8, F-14, F-15, F-16, F-18, S-3, B-1, AH-1W and AH-1Z assets will not have a GREEN CROSS due to Shielded Mild Detonating Cord (SMDC) or Detonation Transfer Assembly (DTA) installed.

WARNING

A GREEN CROSS symbol or RED WARNING stencil indicates the egress status of desert stored assets. Do not perform Desert Operations on stored assets with an unknown egress status. Failure to observe this warning may result in death or injury to personnel.



DETONATION TRANSFER ASSEMBLY (DTA)/SHIELDED MILD DETONATION CORD (SMDC)

6

- c. Verify asset has a painted GREEN CROSS, or a RED stencil, "WARNING EXPLOSIVE CANOPY JETTISON SMDC/DTA INSTALLED". See Table 1-2 for a description of the meaning of the symbol and stencil. Cease all operations and notify Work Center Supervisor if asset does not have a GREEN CROSS or RED stencil, "WARNING EXPLOSIVE CANOPY JETTISON SMDC/DTA INSTALLED."

WARNING

Some AMARG Desert Operations may cause the center of gravity of an asset to change which may cause asset to tip, shift or fall. Review the AMARG specific Safety Summary for additional information. Failure to observe this warning may result in death or injury to personnel.

- d. Assess center of gravity condition of aircraft or asset to account for possible shifts in center of gravity during Desert Operations.
- e. Assess asset for safe condition (e.g. removed components, compromised structure, sufficient support, and ground condition) prior to AMARG Desert Operations.
- f. Assess ground surface condition if trailers, stands or wheeled support equipment will be used.
- g. Assess area, including asset, for biological hazards (e.g. insects, reptiles, animal waste material). Take necessary actions to minimize hazards.
- h. Assess weather conditions prior to operations.
- i. Verify fire extinguisher is available at job site when powered Aerospace Ground Equipment (AGE) is in operation.
- j. Notify Work Center Supervisor if aircraft or asset is not safe for AMARG Desert Operations.

1.8.2 Engine Removal. Engines may be removed from storage aircraft while supported by modules. The following steps may be accomplished to facilitate engine removal.

- a. Place a single thickness of AM2 matting on ground under aircraft to provide engine removal trailer a solid flat surface.
- b. Stack multiple thicknesses of AM2 matting on ground under aircraft to raise engine removal trailer for engine access.

1.8.3 Partial Lifting of Assets. The following procedures may be used for partial lifting, stabilization or leveling of assets during reclamation, towing or disposal follow-on operations. Assets will not be completely supported by use of these procedures. Assets includes complete or partial aircraft, removed components and equipment. Standard aircraft tripod or axle jacks may be used for partial lifting. Requirements for entire aircraft supported by jacks are not applicable for partial lifting operations.

- a. Evaluate asset for potential imbalance and safety concerns prior to lifting and follow-on operations

NOTE

Lifting operations will not be performed if winds exceed 20 knots.

- b. Establish restricted area by placing cones around the asset as warranted.
- c. Identify specific jack points or fittings. (Applicable technical data.)

CAUTION

Asset may shift or slip off a jack that is not completely supported by AM2 matting. Do not lift an asset with a jack that is not completely supported by AM2 matting. Failure to observe this caution may result in damage to aircraft.

- d. Place AM2 matting on the ground to support jack under the lifting point. Position jack per applicable technical data. Ensure all jack support legs are supported on AM2 matting.
- e. Adjust jack ram screw (if equipped) to contact jack point/fitting.

NOTE

Only lift team members are permitted in the restricted area. A minimum of one person will act as a spotter during the lifting operation.

- f. Pressurize the jack to lift the asset the minimum amount.
 - (1) Assess the lifted asset and verify jack is level and supporting the asset with no imbalance condition.
 - (2) Depressurize the jack and correct the placement if adjustments are required.
- g. Pressurize the jack to the minimum lift amount required to perform the follow-on operation.
- h. Perform the follow-on operation.
- i. Release jack pressure and return jack to unpressurized condition when follow-on operation is complete.
- j. Ensure asset is stable and supported prior to removing jacks.
- k. Remove jacks.

1.8.4 Alternate Strut Inflation.

WARNING

Over pressurization of landing gear struts may cause the strut to fail and create flying debris hazards. Do not service struts over max allowable pressure referenced in applicable technical data. Failure to observe this warning may result in injury to personnel or damage to equipment.

NOTE

Locally Manufactured Strut Servicing Valve and Hose Assembly, X201443020-1, is hereafter referred to as the "Valve Assembly."

- a. Close the valve on the high pressure gauge assembly.
- b. Connect the high pressure gauge assembly to the landing gear strut Schrader valve. (Applicable technical data.)
- c. Close the valve on the Valve Assembly.
- d. Connect air chuck of the Valve Assembly to the high pressure gauge assembly and connect the opposite end of the Valve Assembly to the nitrogen cart supply hose.
- e. Inflate landing gear strut, reference applicable technical data, by opening the valve on the Valve Assembly to regulate the supply pressure. Inflate strut to desired height. Do not exceed the "X" dimension unless inflating strut for modulating. Strut may exceed the "X" dimension for modulating actions only.

- f. When landing gear strut is inflated, close the valve on the Valve Assembly and Strut Schrader valve.
- g. Secure nitrogen source and bleed pressure from lines prior to disconnecting the air chuck from the high pressure gauge assembly.
- h. Disconnect the high pressure gauge assembly from the landing gear strut Schrader valve.
- i. Disconnect high pressure gauge assembly from Valve Assembly.

1.8.5 Alternate Strut Deflation.

- a. Close the valve on the Valve Assembly.
- b. Connect the air chuck of the Valve Assembly to the landing gear strut Schrader valve.
- c. Open landing gear strut Schrader valve.
- d. Open and adjust the valve on the Valve Assembly to deflate the strut. Direct the outflow from the Valve Assembly into a suitable container to collect any ejected fluids.
- e. Close landing gear strut Schrader valve.
- f. Disconnect the Valve Assembly from the landing gear strut Schrader valve.

1.9 AMARG COMMON PROCEDURES.

1.9.1 MA-1 Portable Oxygen System Depletion. The MA-1 is a common portable oxygen cylinder used in multiple aircraft as a walk around oxygen source. (Includes the C-5 aircraft.) Deplete the MA-1 cylinder as follows:

- a. Remove the cylinder from the aircraft.
- b. Relocate the cylinder to an open area.
- c. Place the MA-1 oxygen cylinder selector knob to EMER position to release oxygen from the cylinder.
- d. Leave the selector knob in the EMER position.
- e. When oxygen cylinder is fully depleted return the MA-1 cylinder to the normal position on aircraft.

1.9.2 Underwater Acoustic Beacon Battery Removal. The Dukane/Seacom Underwater Acoustic Beacon, Model 120/90 is used on multiple aircraft. It is a 4 inch long silver tube, typically mounted to the flight data recorder or cockpit voice recorder.

- a. Remove the battery from the Dukane/Seacom Underwater Acoustic Beacon (UAB) as follows:
 - (1) Loosen UAB mounting hardware to remove the UAB from the recorder structure.
 - (2) Secure UAB body with appropriate support to prevent crushing or scratching of UAB.
 - (3) Locate spanner wrench holes on end of UAB. Apply spanner wrench to UAB holes. Press firmly to engage wrench in holes to prevent wrench slippage.
 - (4) Turn spanner wrench counterclockwise to loosen battery cover.
 - (5) Remove battery cover.
 - (6) Remove battery.

- b. Reinstall battery cover hand tight.
- c. Reinstall UAB on recorder using removed hardware. Hand tighten hardware, no torque required

1.9.3 Temporary Install. Parts and components may be temporarily installed back on an aircraft or asset in the original location and secured using the following guidance.

1.9.3.1 Install attachment hardware hand tight, no torque required. No safety devices (e.g. safety wire, cotter pins, new lock nuts) required. Cap, plug or reconnect fluid lines. Cover or reinstall electrical connections.

1.9.3.2 Components. Place component in normal installed position. Secure with hardware until sufficiently supported.

1.9.3.3 Aircraft Top and Side Panels.

- a. Place panel in normal installed position. Reinstall all previously removed panel attachment hardware.
- b. If all panel hardware cannot be installed, temporarily install per Paragraph 1.9.3.4, tape open holes, seams and seal with sprayable strippable coating per Chapter 4.

1.9.3.4 Aircraft Bottom Panels.

- a. Place panel in normal installed position. Install one panel attachment hardware at each corner (where any two sides meet). Install a minimum of one panel attachment hardware on each side.
- b. Circular or rounded panels. Install a minimum of four pieces of panel attachment hardware, equally spaced. Spacing may be modified for access.
- c. Place unused panel attachment hardware in a screw bag, and place beneath the panel being installed.

1.10 STORAGE AIRCRAFT WHEEL AND TIRE REMOVAL AND INSTALLATION.

This procedure is for wheel and tire assembly removal for maintenance or inspection of components when the wheel and tire assembly will be immediately reinstalled.

1.10.1 Aircraft preparation. Prepare aircraft as follows:

- a. AMARG Desert Operations. Perform partial lifting procedures per Paragraph 1.8.3. until tire clears the ground.
- b. Non-Desert Operations. Jack aircraft for wheel and tire removal. (Applicable technical data.)

1.10.2 Wheel and tire inspection.

- a. Inspect wheel for cracks, loose or damaged wheel hardware, damage to rim. Completely deflate tire if any discrepancies are identified.
- b. Tire inspection.
 - (1) AMARG Desert Operations. Inspect tire for any visual discrepancies per Chapter 7. Completely deflate the tire if any discrepancies are identified.
 - (2) Non-Desert Operations. Inspect tire for any visual discrepancies. (NAVAIR 04-10-506/TO 4T-1-3.) Completely deflate the tire if any out of limits discrepancies are identified.
- c. Remove the valve cap, and reduce tire inflation pressure to 40 percent of the land base inflation pressure from applicable technical data or 100 Pound-force per Square Inch (PSI), whichever is lower. Use the dual chuck stem kit operating procedures, TO 32A20-3-80-1/NAVAIR 17-1-123.

1.10.3 Wheel and Tire Assembly Removal and Installation.

WARNING

A damaged wheel may fail when the axle nut is removed. Inspect the wheel and deflate the tire if any damage is noted on the wheel before removing the axle nut. Failure to observe this warning may result in death or injury to personnel.

- a. Inspect the wheel for visible damage.
- b. Deflate tire completely if damage is noted to wheel assembly.
- c. Remove axle nut. (Applicable technical data.)
- d. Remove wheel and tire assembly.
- e. Perform maintenance or inspection procedures.
- f. Prior to reinstallation, inspect the area between the tire bead and wheel flange to verify seal has not broken allowing foreign object intrusion. If the bead is broken, send wheel and tire assembly to AMARG tire shop for inspection.
- g. Install wheel and tire assembly. (Applicable technical data.)
- h. Inflate the tire per Chapter 7.

1.11 MUSEUM AIRCRAFT (INCLUDES MUSEUM GENERAL SERVICES ADMINISTRATION (GSA) TRANSFERS).

Museum aircraft will be prepared for transfer per owning agency requirements. The external appearance of museum aircraft should not be altered. Panels for museum aircraft shall be either temporarily installed per Chapter 1 or placed inside the aircraft. All available fasteners for each panel will be retained in a bag and attached to the panel. Disposal preparation procedures from Chapter 9 will be completed on museum aircraft to remove known materials with special disposal requirements, with the following modifications.

1.11.1 Struts, Wheels and Tires. Do not deplete pressurized landing gear struts on museum aircraft or GSA owned aircraft acquired by a qualified museum recipient. Wheel and tire assemblies on museum aircraft or GSA owned aircraft acquired by a qualified museum recipient must be capable of holding pressure. Inflate tire, or reseal tire bead per Chapter 7 or replace the tire.

1.11.2 Instruments. Remove all material with special disposal requirements from cockpit/flightdeck instruments. Place instrument glass faces in a box and place inside of cockpit/flightdeck.

1.11.3 Afterburner or Augmentors. Separate afterburner section from engine (Applicable technical data) on museum aircraft and send with aircraft to museum. Do not separate afterburner section from the engine of an aircraft going to the National Museum of the Air Force, National Naval Aviation Museum or Smithsonian National Air and Space Museum.

1.11.4 Lower Explosive Limit Checks. Perform the Lower Explosive Limits (LEL) check per Chapter 9 but do not mark the exterior of the aircraft with LEL and completion date.

NOTE

The use of Commercially Procured in this Table means that the item must be procured outside the supply system. Items not available in supply system may be commercially procured to support production.

Table 1-1. List of Materials

Safety Summary Reference	Material	Specification	Use
2	Aerosol Paint	A-A-2787	Marking
	Angle of Attack Probe Cover	X201443010	Cover Angle of Attack probes for aircraft sealing
	Barrier Material	MIL-PRF-121, Type I	Covering of components, long term, and interior only.
	Barrier Material	MIL-PRF-131, Class 3	Covering of assets/components, long term, interior or exterior, used under sprayable strippable coatings. May be used in place of MIL-PRF-121, Type I.
	Brush	MIL-B-23958 or equivalent	Hand cleaning
13	Cleaning Compound	MIL-PRF-87937, Type IV	Aircraft washing
12	Cleaning Compound	MIL-PRF-85570, Type II	Hand cleaning, aircraft washing
	Cloth	CCC-C-46, Type 1 Class 7, or Type 1 Class 1, or Type 1 Class 6 or equivalent	Hand cleaning, wiping
6	Corrosion preventive compound	MIL-PRF-16173, Grade 1	Hard film. Applied to refueling probes, fuselages, wings, and external surfaces without any additional coating application.
6	Corrosion preventive compound	MIL-PRF-16173, Grade 2	Soft film. Applied to rotor blade attaching points, rotor hubs, propeller shafts, transmissions and gearboxes, bare steel, and internal surfaces without any additional coating application. Do not apply to chrome plated surfaces.
6	Corrosion preventive compound	MIL-PRF-16173, Grade 4	Transparent, non-tacky film. Applied to internal surfaces without any additional coating application, external surfaces with additional coating application.
10	Corrosion preventive compound	MIL-PRF-81309, Type II	Thin, soft film. General interior corrosion protection (except Avionics).
10	Corrosion preventive compound	MIL-PRF-81309, Type III	Thin, soft film. General interior corrosion protection (Avionics).
17	Corrosion preventive compound	MIL-DTL-85054	Water displacing clear film, applied to unpainted metals.
	Cover, Aircraft, (Material)	MIL-P-58102	Alternate material for aircraft covers in place of MIL-PRF-6799 coating.
	Cushioning Material	Surlyn 9720	Cushioning sharp edges, filling small gaps.
	Cushioning Material	A-A-59136, Class 1, Type I, Grade A	Cushioning sharp edges, filling small gaps, where water absorption should be minimized. (e.g. rotor heads, blades, etc.)
9	Degreasing Solvent	MIL-PRF-680, Type II	Hand Cleaning
5	Desiccant	MIL-D-3464, Type 1	Humidity reduction for sealed engines.
	Desiccant Suspension Device	Commercially procured	Desiccant holder for engines or other areas requiring desiccant. Commercially procured dish draining rack.
4	Detergent, General Purpose	MIL-D-16791	Canopy seal cleaning
	C flute	ASTM D4727 V3C or equivalent.	Minimum specification, single wall, weather resistant, corrugated.

Table 1-1. List of Materials - Continued

Safety Summary Reference	Material	Specification	Use
	Flannel Cloth	A-A-50129	Cover canopies prior to coating application.
	Fuel Sample Bottle	Wheaton 209677SP or equivalent	Taking aircraft fuel tank samples
11	Grease	MIL-PRF-81322	Flap track lube, wheel bearing lube, general lubricant
	Hydraulic Oil Sample Bottle	62000 (Stocklisted) or equivalent	Taking hydraulic system oil samples
16	Isopropyl Alcohol	TT-I-735	Cleaning oily surfaces prior to coating or tape application
	Kool Kote Mastic	KM101 Commercially procured	Repair of defects in sprayable strippable top coat
	Metal Tags	Commercially procured	Asset identification
	Mold Release, Wax, Water emulsion	P-W-155	Preparation of de-icer boots (except propellers) prior to sprayable strippable coating application. (Release agent)
3	Nitrogen	A-A-59503/Mechanically generated nitrogen	Tire servicing
	Oil Sampling Kit	PD88MMIPD599 (Stocklisted) or equivalent	Taking engine oil samples
15	Plastic Polish	P-P-560 (Tex-Whiz 5602260 Commercial)	Preparation of transparent acrylic surfaces (Canopies), light lenses. (Release agent)
	Plastic Sheet	Commercially procured	Masking of surfaces to prevent overspray
7	Preservation Oil	MIL-PRF-6081, Grade 1010	Preserve fuel systems and engines
	Safety Wire	SAE-AS-5685/ASTM A580	Safety wiring hardware, pitot tube covers
	Screen	L-S-125, Type II, Class 1	Filling holes and openings to prevent insect and animal intrusion, while allowing air exchange.
	Shrink Wrap	14-200-7W or equivalent. Commercially procured	Wrapping components for shipment
	Shrink Wrap Tape	703WH or equivalent. Commercially procured	Tape to close and secure shrink wrap
8	Sprayable, stripable coating (Black)	MIL-PRF-6799, Type II, Class 1	Coating, black, base coat, preservation of assets
8	Sprayable, stripable coating (White)	MIL-PRF-6799, Type II, Class 6	Coating, white, top coat, preservation of assets
	Static Vent Cover	PN 207002	Static port cover for sealing aircraft
1	Stencil Ink	A-A-208	Marking assets
	Tape	Commercially procured (Red)	Temporary Marking - fuel tape patch
	Tape	AMS-T-22085, Type II (3M 481)	Sealing, attachment of barrier material, fiberboard, sealing of gaps and holes.
	Tape, Insulation	A-A-59163, Type II	Sealing electrical connectors for storage. 0.020 thick recommended, 0.040 acceptable also.
	Ventilator Plate	X20178452	Venting aircraft
	Ventilator Insulation	X20178451	Venting aircraft
	Vent Tubing	MIL-DTL-24466 or equivalent	Venting aircraft and fuel areas
	Vinyl Closure	GSA Sourced, Transhield or equivalent	Resealable vinyl closure for windows and doors

Table 1-1. List of Materials - Continued

Safety Summary Reference	Material	Specification	Use
14	Wax, Aircraft, water proof	Wax, Aircraft, Waterproof, Formerly MIL-W-18723, commercially procured under MIL Spec	Preparation of surfaces with stencils, decals, or neoprene, composite surfaces and rain erosion resistant material coated surfaces prior to sprayable strippable coating application. (Release agent)

Table 1-2. Aircraft Markings

Reference See Figure 1-1.	Location	Symbol	Color/Size	Meaning
1	Left front of aircraft	+	Green 10 inch X 10 inch	Egress Status: Aircraft is egress safe, seats and canopy removal devices have been removed or safed.
1, 2	Both sides of aircraft below canopy	WARNING EXPLOSIVE CANOPY JET-TISON SMDC/ DTA IN- STALLED	Red/Minimum 1 inch	Egress Status: Aircraft is egress safe, seats and most canopy removal devices have been removed or safed. Only Shielded Mild Detonating Cord or Detonation Transfer Assembly is installed in egress system.
	Nose of aircraft	Tape Patch	Red/3 inch - 12 inch	Aircraft has fuel on board
	Location of Radioactive material	R	Red/4 inch - 6 inch	Radioactive material
	Strut	D	Red/2 inch - 5 inch	Strut does not stay inflated
	Prominent place on aircraft	D	Red/12 inch - 16 inch	Aircraft is being prepared for Disposal
	Over the Disposal "D"	X (over the red D) YYYYMMDD	Red/12 inch - 16 inch	Aircraft Disposal preparation is complete
1	Left front of aircraft	BALLAST IN- STALLED	Black/2 inch	Ballast installed
1	Left front of aircraft, or per Sealing Diagram	DO NOT TOW AIRCRAFT WITH RUD- DER SEALED	Red/Minimum 1 inch	Aircraft rudder is sealed
	On sealed area over removed panel	DO NOT STEP - FIBER- BOARD	Red/Minimum 1 inch	Panel is removed and fiberboard cover under sealing material. Do not step on area
1, 2, 3, 4	See Figure 1-1.	79000480	Black/4 inch	Aircraft Identification Number - Air Force 8 digit serial number (79000480 is an example number only).
1, 2, 3, 4	See Figure 1-1.	00160417	Black/4 inch	Aircraft Identification Number - Navy BUNO (00160417 is an example number only).
	Left front of aircraft	LEL YYYYMMDD	Black/3 inch	LEL readings acceptable.
	Side of uninstalled external fuel tank	LEL YYYYMMDD	Black/3 inch	LEL readings acceptable.

Table 1-2. Aircraft Markings - Continued

Reference See Figure 1-1.	Location	Symbol	Color/Size	Meaning
	In a prominent location on the asset	Lettering	Black or Red Minimum 1 inch - 4 inch	Other Information
	Front and Back of Engine Container	Engine Type Model Series Engine Serial Number AMARG Asset ID	Black or Red Minimum 1 inch	Identifies type of Engine in storage
	Left and Right side of Engine cover or wrapping	Engine Type Model Series Engine Serial Number AMARG Asset ID	Black or Red Minimum 1 inch	Identifies type of Engine in storage
	Front and Back of Propeller Blade	Propeller Serial Number AMARG Asset ID	Black or Red Minimum 1 inch	Identifies type of Propeller in storage
	Left and Right side of Rotor Blade Container	AMARG Asset ID	Black or Red Minimum 1 inch	Identifies Type of asset in storage
	Inlet and Exhaust Area	DESICCANT INSTALLED X BAGS	Red/Minimum 1 inch	Desiccant installed in engine inlet and exhaust. X is the number of desiccant bags.
	On Hydrazine Panel	H70 SYSTEM PURGED	Red/Minimum 1 inch	Hydrazine system has been purged.

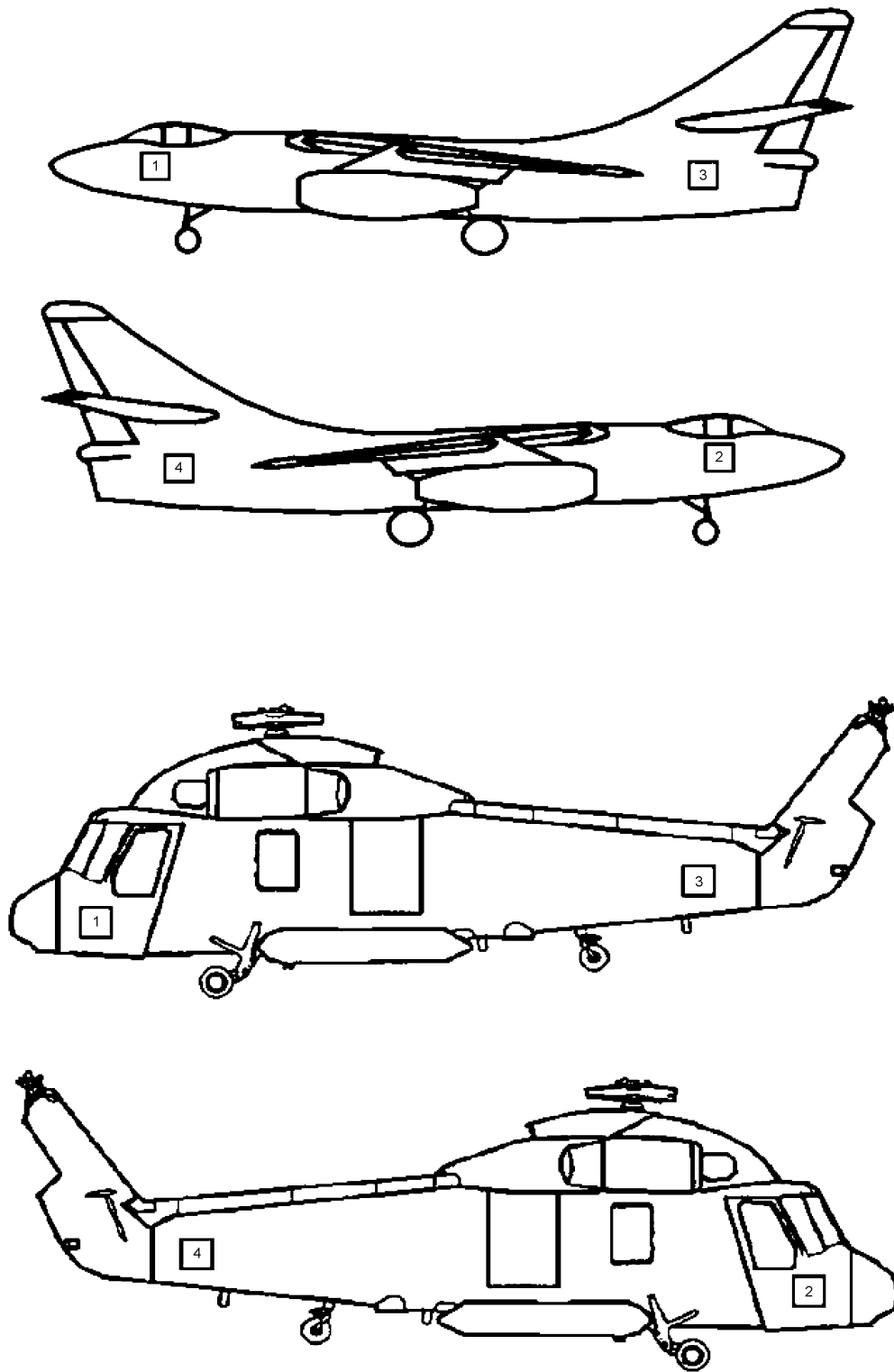

TO-1-1-686-001

Figure 1-1. Aircraft Marking Location

CHAPTER 2

LONG-TERM STORAGE PRESERVATION PROCEDURES

2.1 GENERAL.

This chapter describes procedures for pre-induction, preservation, storage preparation, cleaning, lubrication and corrosion control, in storage inspection and special inspection (Table 2-1). This chapter contains Type 1000, 1500, 2000, and 4000 storage procedures. Type 3000 preservation description is found in Paragraph 8.4.

2.2 PRE-INDUCTION PROCEDURES.

This chapter provides Pre-Induction procedures for aircraft and engines prior to preservation. Aircraft and engines do not require additional preservation treatment if preservation has been accomplished by owning agency. Aerospace Maintenance and Regeneration Group (AMARG) shall follow owning agency guidance for storage of mishap aircraft at AMARG.

2.2.1 Non Fly-in Aircraft or Engines. Aircraft or engines arriving by truck or airlift transport will be inspected per this Section. Perform all the steps in Paragraph 2.2.2 that can be accomplished, based on aircraft condition (e.g. if engine is not installed, do not perform engine oil sampling).

2.2.1.1 Perform a visual exterior inspection of the aircraft or engine for damage. Annotate findings and notify owning agency of damage.

2.2.2 Induction Procedures.

NOTE

- Discrepancies will be documented using the owning agency aircraft forms. If no owning agency forms are available, AMARG may use the Air Force Technical Order (AFTO) 781 series forms to document discrepancies. AFTO 781 series forms are used to document discrepancies only and do not have to be completed per regulation.
- For recurring preservation, perform Step d, Step e, and Step f only.

a. Perform aircrew debrief.

b. Collect available records and deliver to AMARG records section.

c. Check aircraft for manufacturer's data plate. If data plate is not present notify AMARG security forces and business office.

NOTE

Barrier material, MIL-PRF-131, Class 3, and tape, AMS-T-22085, Type II, may be used as covering material if original equipment is not available.

d. Make aircraft maintenance safe. (Applicable technical data.) If applicable technical data does not specify, install ground safety locks, ground wires, dust excluders and foreign object covers. (Applicable technical data.)

- e. Perform engine intake and exhaust inspections. (Applicable technical data.)

NOTE

Aircraft with no Postflight or equivalent inspection will be inspected by procedures in Appendix A.

- f. Perform aircraft Basic Postflight or equivalent inspection. (Applicable technical data.) The aircraft Postflight or equivalent inspection is performed with the intent that the aircraft is being placed into storage, not flight preparation. Not all systems will be serviced.
 - (1) Service systems required for preservation actions (e.g. hydraulic systems, etc.)
 - (2) Do not service systems that will be deactivated for preservation (e.g. oxygen systems, etc.).

NOTE

If not specified in applicable technical data, oil samples will be taken within 30 minutes of engine shutdown. Oil sampling may be performed after engine preservation run. Inoperable engines or engines preserved prior to arrival at 309 AMARG do not require oil sampling.

- g. Perform engine oil sampling. (Applicable technical data.)
- h. Verify and document engine serial number(s).

NOTE

If aircraft is not equipped with engine data system, aircraft engine information will be obtained from aircraft forms and aircrew debrief.

- i. Perform engine data download, if capable. (Applicable technical data.)
- j. Perform hydraulic system contamination check. (Applicable technical data.)
- k. Set helicopter rotor brake or gust lock if equipped. Tiedown helicopter rotor blades if installed. (Applicable technical data.)
- l. Verify ammunition from gun system and ammunition cans if equipped has been removed. (Applicable technical data.)
- m. Cage all gyros (if applicable). (Applicable technical data.)
- n. Drain and flush aircraft lavatory. (Applicable technical data.) Leave drains open to permit continued drying and prevent water collection during storage.
- o. Remove trash and debris from aircraft interior.
- p. Remove perishable items and discard (e.g. Emergency rations).
- q. Remove flight equipment (e.g. parachutes, exposure suits, pressure suits, flotation gear, and first aid kits). Process per owning agency guidance.
- r. Safety wire or lock primary and emergency landing gear controls to DOWN position.
- s. Apply red tape (commercially procured) patch to nose of aircraft to indicate fuel is onboard.
- t. Rotor and Hub Systems (Helicopters Only):
 - (1) Remove main rotor blades. (Applicable technical data.)

- (2) Remove tail rotor blades. (Applicable technical data.)
- (3) Document serial numbers of main and tail rotor blades.



MIL-PRF-16173, COMPOUND, CORROSION PREVENTIVE

7

- (4) Apply corrosion preventive compound MIL-PRF-16173, Grade 2, to main and tail rotor blade and hub attachment points.
- (5) Store main and tail rotor blades per Chapter 3.

2.3 PRESERVATION PROCEDURES.

NOTE

Preservation procedures in this chapter shall be followed unless owning agency provides other guidance in a Statement of Work.

2.3.1 Fuel System Preparation.

- a. Actuate water drain for each tank. (Applicable technical data.) Drain fuel sample into a clear bottle. Swirl bottle and check for visible sediment, fibers, and hazy or cloudy fuel.
 - (1) If fuel has visible sediment, fibers, or is hazy or cloudy, do not defuel the aircraft per normal procedures. Notify the local fuels management branch for defueling assistance and defuel in accordance with local policies and procedures. Notify owning agency that the aircraft arrived at AMARG with contaminated fuel.
 - (2) If fuel does not have visible sediment, fibers, and is not hazy or cloudy, defuel the aircraft per normal procedures. (Applicable technical data.)
- b. Open all fuel system drains including low point drains. Remove as much fuel as possible from fuel system. Close all drains.
- c. Remove red tape patch from nose of aircraft.

2.3.2 Fuel System Preservation.

NOTE

- If fuel system or power plant preservation is not accomplished, document in the appropriate aircraft forms.
- Power plant preservation may be performed in conjunction with fuel system fill and drain preservation method.

2.3.2.1 Fill and Drain Method.



MIL-PRF-6081, LUBRICATING OIL, JET ENGINE

8

- a. Service aircraft with preservation oil, MIL-PRF-6081, Grade 1010, using applicable aircraft fuel servicing technical data.
- b. Operate fuel transfer system (Applicable technical data.) to coat entire fuel system (including lines, valves, and pumps) and air refueling systems with preservation oil.

- c. Perform Power Plant Preservation from Paragraph 2.3.3 if power plants will be preserved in conjunction with the Fill and Drain method.
- d. Drain excess preservation oil from fuel cells using applicable aircraft defuel procedures.

2.3.2.2 Fuel Cell Misting Method.

- a. When fuel system cannot be preserved by the fill and drain method, open fuel cell filler openings and access panels. (Applicable technical data.)



MIL-PRF-6081, LUBRICATING OIL, JET ENGINE

8

- b. Spray preservation oil, MIL-PRF-6081, Grade 1010, on all accessible interior surfaces of fuel cells.
- c. Install all open access fuel cell panels and close all filler openings. (Applicable technical data.)

2.3.3 Power Plant Preservation. This section covers power plant preservation including engines and Auxiliary Power Units (APUs). Power plant preservation may be performed in conjunction with fuel system fill and drain preservation method. When using fuel cell misting preservation method use applicable technical data or owning agency guidance for power plant preservation. Engines that cannot be preserved by the operational method may be preserved by the alternate motoring method. Preserve non-rotatable or non-operational engines by cold preservation method. (Army aircraft only) Ground run-up is required every 14 days until engine, fuel control, auxiliary power unit, transmission and drive train have been preserved for storage.

2.3.3.1 Operational Method.

NOTE

- Aircraft canopy jettison and fire suppression actuating devices are removed from depreserved storage aircraft. Contact the owning agency for engine preservation guidance with non-functional aircraft systems.
 - Some engines may require a higher or lower revolution per minute (rpm) or throttle setting for engine preservation. Use specified rpm or throttle setting for preservation. If not specified, preserve engines at 70 to 80 percent rpm.
- a. Start and operate turbojet or turbofan engines at specified rpm or throttle setting, or 70 to 80 percent rpm, turboprop engines at ground idle settings. Run engine(s) for a minimum of five minutes. (Applicable technical data.)
 - b. Shut down engine(s) using normal shutdown procedures. (Applicable technical data.)

2.3.3.2 Alternate Motoring Method.

- a. Deactivate the engine ignition system. (Applicable technical data.)
- b. Place throttle at idle. Motor the engine with the fuel feed valve(s) open. (Applicable technical data.) Motor the engine for the equivalent of two starting cycles using the starter (observe starter duty cycle limitations).
- c. Place throttle at cut-off and close engine fuel feed valve(s). (Applicable technical data.)

2.3.3.3 Cold Preservation Method.



MIL-PRF-6081, LUBRICATING OIL, JET ENGINE

8

Cold preservation of non-rotatable or non-operational engines is accomplished by disconnecting specified engine fuel lines and connecting a MIL-PRF-6081 Grade 1010 source. MIL-PRF-6081 Grade 1010 oil is pumped into the engine fuel system to displace engine fuel. If applicable technical data does not contain cold preservation procedures, contact owning agency for specific procedures.

2.3.3.4 APUs.

- a. Prepare aircraft APU(s) for run. (Applicable technical data.)
- b. Operate APU units at no load condition for a minimum of five minutes. (Applicable technical data.)
- c. Shut down APU using normal shutdown procedures. (Applicable technical data.)

2.3.4 Helicopter Transmissions and Gearboxes.

- a. Check applicable technical data for transmission and gearbox operating and preservation fluid specifications. Do not drain gearbox or transmission if operating fluid and preservation fluid is the same specification.
- b. Drain and service, or service transmissions and gearboxes with applicable fluid for preservation. (Applicable technical data.)

NOTE

AMARG will not operate helicopter transmissions and gearboxes per applicable technical data. Hand rotation will be utilized in place of operation of transmissions and gearboxes in applicable technical data.

- c. Hand rotate turbo shaft type transmissions and gearboxes for a minimum of ten revolutions.

2.4 STORAGE PREPARATION PROCEDURES.

2.4.1 Electrical Systems.

- a. Remove dry cell batteries (e.g. emergency locator transmitter, life-support equipment, emergency lighting etc.). (Applicable technical data.)
- b. Remove aircraft batteries after aircraft wash is completed and flaps are retracted. (Applicable technical data.) Turn into AMARG battery shop. Process per owning agency guidance.
- c. Seal aircraft battery connector using electrical insulation tape, A-A-59163, Type II, or wrap with barrier material, MIL-PRF-121, Type I, and tape, AMS-T-22085, Type II.

2.4.2 Pneumatic Systems. Deplete pressure accumulators. Leave system open to permit continued drying and prevent water collection during storage.

2.4.3 Photographic Systems.

- a. If cameras are installed, process per owning agency guidance.
- b. Inspect viewfinders for moisture as indicated by fogging of optical elements or unsafe humidity indicator readings. Perform corrective procedures if moisture is detected. (Applicable technical data.)

- c. Cover viewfinders with equipment covers or with barrier material, MIL-PRF-121, Type I, and tape, AMS-T-22085, Type II.

2.4.4 Safety and Survival Systems.

- a. Preserve all survival equipment removed from aircraft either for separate storage or for turn-in to supply. (Applicable technical data.)
- b. Remove cartridge actuated and percussion actuated devices and fire bottle squibs. (Applicable technical data.) Process per owning agency guidance.
- c. De-arm ejection seats and mechanisms. (Applicable technical data.)
- d. Mark egress status indicator on aircraft per Paragraph 1.6.
- e. If drains are installed, drain moisture from pneumatic canopy or door seals. (Applicable technical data.)

2.4.5 Oxygen Systems.

- a. Remove portable chemical oxygen generators. Contact owning agency for disposition of chemical oxygen generators.
- b. Bleed portable oxygen cylinders to 0 PSI and secure in normal position on aircraft.
- c. Drain and purge low and high-pressure gaseous oxygen systems. (Applicable technical data.)
- d. Drain and purge liquid oxygen system. (Applicable technical data.)
- e. Protect oxygen system regulators and hoses by covering regulator openings and hose connections with barrier material, MIL-PRF-121, Type I, and tape, AMS-T-22085, Type II.

2.4.6 Utility Systems.

- a. Service air conditioning systems (non-refrigerant systems) for preservation. (Applicable technical data.)

NOTE

Review the AMARG specific Safety Summary for information on refrigerant recovery.



LIQUID REFRIGERANT

9

- b. Recover refrigerant from evaporator and condenser units. (Applicable technical data.)
- c. Place all air conditioning system controls in the off position. (Applicable technical data.)
- d. Protect Cabin Air and Pressure Suit Regulators by covering regulator openings and hose connections with barrier material, MIL-PRF-121, Type I, and tape, AMS-T-22085, Type II.
- e. Drain water tanks, pumps and lines; air dry and leave drains open. (Applicable technical data.)

2.4.7 Additional Requirements.

- a. Perform wheel bearing lube. (Applicable technical data.) (Do not remove outer wheel bearing races.)
- b. Service separate aircraft brake system hydraulic reservoir, if equipped (Applicable technical data.)

- c. Service Shimmy Damper. (Applicable technical data.)
- d. Remove windshield wiper blades and arms. (Applicable technical data.) Wrap with barrier material, MIL-PRF-121, Type I, tape, AMS-T-22085, Type II, and store in aircraft.
- e. Drain window washer fluid reservoir. (Applicable technical data.) Leave drain open.
- f. Remove classified items. (Applicable technical data.) Process per owning agency guidance.
- g. Inventory aircraft and record results in accordance with CNAFINST 4790.2 (Series) for Navy aircraft, AFI 21-103 for Air Force aircraft, and DA PAM 738-751 for Army aircraft.
- h. Perform radiation survey.

2.5 CLEANING, LUBRICATION AND CORROSION PROCEDURES.

2.5.1 Pre-Wash Lubrication. Perform pre-wash lubrication. (Applicable technical data), (Navy Only).

NOTE

When technical data specific equipment and wheel covers are not available, barrier material, MIL-PRF-131, Class 3, tape, AMS-T-22085, Type II, and alternate wheel covers may be used.

2.5.2 Aircraft Wash.

- a. Fully extend aircraft flaps with jackscrews and tracks.



MIL-PRF-87937, CLEANING COMPOUND, AIRCRAFT, TYPE II, IV, & V

10



MIL-PRF-85570, CLEANING COMPOUND, AIRCRAFT

1

- b. Wash aircraft exterior, engines, and components (Applicable technical data.) using cleaning compound, MIL-PRF-87937 Type IV or MIL-PRF-85570 Type II detergent. Dilute per tables listed in TO 1-1-691 and NAVAIR 01-1A-509-2/TM 01-1500-344-23-2.

- c. Perform aircraft post wash lubrication. (Applicable technical data.)



MIL-PRF-81322, GREASE, AIRCRAFT GENERAL PURPOSE

11

- d. Coat flap jackscrews and tracks with a thin even film of MIL-PRF-81322 grease. Fully retract flaps. Leave flaps retracted.
- e. Verify aircraft drain holes are open by inserting a probe, such as a pipe cleaner.

NOTE

US Army aircraft will be rendered non-tactical during storage processing. Return to tactical use by the US Army requires repainting in accordance with TM 1-1500-345-23 Painting and Marking of Army Aircraft.

2.5.3 General External Corrosion Prevention and Control. The following processes are limited to bare metal areas exceeding one-half inch by one half inch.

- a. Inspect aircraft exterior and visible accessible areas for coating failures and associated corrosion.

NOTE

Feather edge sanding shall not be required prior to touch-up painting for storage.

- b. Repair areas with minor coating failures (e.g. chipped paint, scratches, paint missing from outer edges of skin panels exposing bare metal) as follows.



Metal scrapers will damage aircraft surfaces. Do not use metal scrapers to remove peeling or lifted coating. Failure to observe this caution may result in damage to aircraft.

- (1) Remove peeling or lifted coatings around the damaged area using a plastic or phenolic scraper.

NOTE

When touch-up repair cannot be accomplished or materials are not available, temporarily treat the damaged areas with Corrosion Prevention Compound (CPC). Apply MIL-DTL-85054, (preferred) or other time limited CPCs listed in TO 1-1-691 Table 3-6, NAVAIR 01-1A-509-2/Army TM 1-1500-344-23-2, Table 8-1 for protection until permanent touch up repairs can be accomplished.

- (2) Repair damaged conversion coatings per TO 1-1-8, Chapter 3.

NOTE

Bare fasteners do not require primer or topcoat.

- (3) Touch-up areas using one of the approved touch-up materials and processes in TO 1-1-8, Chapter 5. Touch-up primer will overlap original surface coating by at least one-half inch.



MIL-PRF-85285, TOPCOAT

13

- (4) Apply MIL-PRF-85285 topcoat per aircraft paint block to areas not coated with sprayable strippable coating.
- (5) Apply sprayable strippable coating per Chapter 4, to areas not covered by MIL-PRF-85285 topcoat.

NOTE

Corrosion inspection is performed after aircraft wash. Specific, additional cleaning may be performed if required. Do not remove panels, closures or covers that require follow on maintenance in order to perform the corrosion inspection.

2.5.4 Corrosion Prone Areas. Inspect corrosion prone areas as follows:

- a. Coating system. Visually inspect aircraft external surfaces for evidence of coating system failure.
- b. Fasteners. Visually inspect external bare fasteners for evidence of corrosion.
- c. Gun Gas Exhaust area. Visually inspect external gun gas exhaust areas for evidence of corrosion.

- d. Wheel wells. Visually inspect wheel well area, including cables and electrical connectors for evidence of corrosion.
- e. Landing Gear. Visually inspect landing gear strut, support/retract structure and wheels, for evidence of corrosion.
- f. Flap Wells. Visually inspect inside of flap wells with flaps extended, for evidence of corrosion.
- g. Inlet Duct. Visually inspect inlet duct leading edge for evidence of corrosion.
- h. Wing fold joints. Visually inspect external areas around wing fold joints for evidence of corrosion. If wings are folded, visually inspect exposed wing fold areas for evidence of corrosion. Do not fold or unfold wings for this inspection, unless directed by the owning agency.
- i. Fin fold joints. Visually inspect external areas around fin fold joints for evidence of corrosion. If fin is folded, visually inspect exposed fin fold areas for evidence of corrosion. Do not fold or unfold fin for this inspection, unless directed by the owning agency.
- j. Wing leading edge. Visually inspect leading edges of wings for evidence of corrosion.
- k. Control surface leading edge. Visually inspect externally visible leading edges of control surfaces for evidence of corrosion.
- l. Piano Hinges. Visually inspect externally visible piano type hinges for evidence of corrosion.
- m. Control Cables. Visually inspect externally visible control cables for evidence of corrosion. Visually inspect internally visible control cables (cargo type aircraft only) for evidence of corrosion. (Internally visible control cables are control cables visible without removal of insulation or aircraft interior or exterior panels.)
- n. Relief Tube Area. Visually inspect external relief tube area for evidence of corrosion.
- o. Battery Compartment. Visually inspect battery compartment for evidence of corrosion after battery is removed.
- p. Battery Vent. Visually inspect external battery vent for evidence of corrosion.
- q. Electrical Connectors. Visually inspect external electrical connectors that are exposed to the outside environment for evidence of corrosion.

NOTE

AMARG will repair light corrosion per applicable technical data. Moderate and severe corrosion will be treated per owning agency guidance.

2.5.5 Corrosion Treatment. Remove and treat light corrosion. (Applicable technical data.)

2.5.6 Electrical Connectors. Protect disconnected electrical connectors with plastic caps or cover and seal connector using electrical insulation tape, A-A-59163, Type II. Secure connectors as near to the point of removal as possible. Install plastic covers on open receptacles.

2.5.7 Lights. Check lights and light cavities for entrapped moisture. If moisture is present, drain and dry. (Applicable technical data.)

2.5.8 Refueling Probes.



MIL-PRF-16173, COMPOUND, CORROSION PREVENTIVE

7

Apply MIL-PRF-16173, Grade 1 to unpainted areas on in-flight refueling probe.

2.5.9 Static Vent Systems. Drain all water from static vent systems. (Applicable technical data.)

2.5.10 Arresting Gear.



MIL-PRF-16173, COMPOUND, CORROSION PREVENTIVE

7

Apply MIL-PRF-16173, Grade 1 to unpainted areas on arresting gear.

2.5.11 Camera Mounts. Clean camera mounts and treat unpainted portions per TO 1-1-691 or NAVAIR 01-1A-509-2/TM 01-1500-344-23-2.

2.6 SEAL AIRCRAFT.

Install aircraft top cover or seal aircraft as specified in the aircraft Sealing Diagram.

2.7 IN STORAGE INSPECTION.

In storage inspection interval for Types 1000, 1500, 2000, and 4000 is 180 days plus or minus 30 days. See Table 2-2 for in storage inspection requirements for Type 1000, 1500, 2000 and 4000. (Navy only) Aircraft with top covers will be inspected per Table 2-2, Items 1 and 12, every 90 days, plus or minus 15 days.

2.8 SEVERE WEATHER INSPECTION.

Evaluate desert stored assets after periods of severe weather. Check for damage, movement, positioning and support. Check security of tie downs, and condition of aircraft covers and sealing materials. Report discrepancies.

Table 2-1. Long Term Storage Preservation Requirements by Storage Types

Process	Paragraph Number	Storage Type		
		1000/1500	2000	4000
PREINDUCTION PROCEDURES:	Paragraph 2.2.			
Non Fly-in Inspection	Paragraph 2.2.1.1.	X	X	X
Check for manufacturer's data plate	Step c.	X	X	X
Maintenance safe aircraft	Step d.	X	X	X
Perform engine intake and exhaust inspection	Step e.	X	X	X
Complete Basic Post Flight Inspection	Step f.	X	X	X
Perform engine(s) oil sampling	Step g.	X	X	X
Verify and document engine serial number	Step h.	X	X	X
Perform engine data download	Step i.	X	X	X
Perform hydraulic system contamination check	Step j.	X	X	

Table 2-1. Long Term Storage Preservation Requirements by Storage Types - Continued

Process	Paragraph Number	Storage Type		
		1000/1500	2000	4000
Set rotor brakes	Step k.	X	X	X
Verify ammunition removed	Step l.	X	X	X
Cage all gyros	Step m.	X	X	
Drain and flush aircraft lavatory	Step n.	X	X	X
Remove loose trash and debris	Step o.	X	X	X
Remove perishable items and discard	Step p.	X	X	X
Remove flight equipment	Step q.	X	X	X
Landing gear preparation	Step r.	X	X	X
Apply red tape patch to nose of aircraft	Step s.	X	X	X
Rotor and Hub Systems (Helicopters Only)				
Remove main rotor blades	Step t(1).	X	X	X
Remove tail rotor blades	Step t(2).	X	X	X
Document main and tail rotor blades serial numbers	Step t(3).	X	X	X
Apply corrosion preventive compound	Step t(4).	X	X	Note 1
Store main and tail rotor blades	Step t(5).	X	X	X
PRESERVATION PROCEDURES:				
Fuel System Preparation				
Actuate water drains	Step a.	X	X	X
Defuel aircraft fuel system	Step a(2).	X	X	X
Open all fuel system drains including low point drains	Step b.	X	X	X
Remove red tape patch from nose of aircraft	Step c.	X	X	X
Fuel System Preservation	Paragraph 2.3.2.	X	X	X
Power Plant Preservation	Paragraph 2.3.3.	X	X	Note 1
Helicopter Transmission and Gearbox Preservation	Paragraph 2.3.4.	X	X	Note 1
STORAGE PREPARATION PROCEDURES				
Electrical Systems	Paragraph 2.4.1.	X	X	X
Pneumatic Systems	Paragraph 2.4.2.	X	X	X
Photographic Systems	Paragraph 2.4.3.	X	X	X
Safety and Survival Systems	Paragraph 2.4.4.	X	X	X
Oxygen Systems	Step a through Step d.	X	X	X
Protect oxygen system hoses, regulators/hose connections	Step e.	X	X	
Utility Systems				
Service air conditioning systems (non-refrigerant systems)	Step a.	X	X	
Recover refrigerant systems (owning agency).	Step b.	X	X	X
Place all air conditioning system controls off	Step c.	X	X	X
Protect Cabin Air and Pressure Suit/regulators	Step d.	X	X	
Drain water tanks, pumps, and lines	Step e.	X	X	X
Additional Requirements				
Perform wheel bearing Lube	Step a.	X	Note 2	

Table 2-1. Long Term Storage Preservation Requirements by Storage Types - Continued

Process	Paragraph Number	Storage Type		
		1000/1500	2000	4000
Service brake system	Step b.	X	X	
Service Shimmy Dampers	Step c.	X	X	
Remove windshield wiper blades and arms	Step d.	X	X	
Drain window washer fluid	Step e.	X	X	X
Remove and process classified items	Step f.	X	X	X
Inventory aircraft and record results	Step g.	X	X	X
Perform Radiation Survey	Step h.	X	X	X
CLEANING, LUBRICATION AND CORROSION PROCEDURES				
Pre-wash lubrication	Paragraph 2.5.1.	Note 2	Note 2	
Wash aircraft exterior	Step a and Step b.	X	X	
Post wash lubrication	Step c and Step d.	X	X	
Verify drain holes are open	Step e.	X	X	
General External Corrosion Prevention and Control				
Inspect aircraft exterior for coating failures and corrosion	Step a.	X	X	Note 1
Repair minor coating failures	Step b.	X	X	Note 1
Perform visual inspection of corrosion prone areas	Paragraph 2.5.4.	X	X	Note 1
Remove and treat light corrosion	Paragraph 2.5.5.	X	X	Note 1
Protect disconnected electrical connectors	Paragraph 2.5.6.	X	X	
Check lights and light cavities for entrapped moisture	Paragraph 2.5.7.	X	X	
Coat unpainted exterior portion of in-flight refueling probe	Paragraph 2.5.8.	X	X	
Drain all water from static vent system	Paragraph 2.5.9.	X	X	
Apply CPC to arresting gear	Paragraph 2.5.10.	X	X	
Clean camera mounts and treat unpainted portions	Paragraph 2.5.11.	X	X	
SEAL AIRCRAFT	Paragraph 2.6.	X	X	Note 3
IN STORAGE INSPECTION PROCEDURES	Paragraph 2.7.	X	X	X
SEVERE WEATHER INSPECTION	Paragraph 2.8.	X	X	X
48 Month Recurring Preservation (Type 1000 storage aircraft and engines only)		X		
NOTE 1: Owing Agency Requested				
NOTE 2: Navy Only				
NOTE 3: Aircraft will be sealed unless owning agency specifies sealing is not required in statement of work.				

Table 2-2. In Storage Inspection Requirements

Number	Action to be Taken	Type Storage			
		1000	1500	2000	4000
1	Document discrepancies identified during the storage inspection and submit AFMC Form 173 for repair unless guidance is provided within table.	X	X	X	X
2	Inspect safety locks (landing gear and arresting gear) for proper installation and serviceability.	X	X	X	X
3	Inspect aircraft tiedown cables, augers and chocks for placement, condition, and security. Tighten loose cables and adjust chocks.	X	X	X	X
4	Inspect landing gear tires for inflation.	X	X	X	
5	Inspect landing gear struts for bottomed out condition.	X	X	X	
6	Inspect aircraft sprayable strippable coating for condition and security.	X	X	X	X
7	Inspect aircraft exterior for evidence of major fluid leakage.	X	X	X	X
8	Inspect visually accessible areas of the aircraft for significant corrosion.	X	X	X	
9	Inspect doors, sliding canopies, control surfaces, etc. for security.	X	X	X	X
10	Inspect external vents for damage and clogged filters.	X	X	X	
11	Inspect aircraft and engine drains for obstructions (Applicable Sealing Diagram). Open obstructed drains.	X	X	X	
12	Inspect aircraft top cover material for damage due to chafing, tears, or delamination. Inspect strap attachment points for security. Check straps for tension. Tighten loose straps.	X	X		
13	Inspect aircraft markings for legibility.	X	X	X	X
14	Record date and extent of preservation maintenance in the appropriate aircraft processing record.	X	X	X	X
15	Inspect aircraft modules for serviceability if installed. See Step a.	X	X	X	X

CHAPTER 3

PRESERVATION AND INSPECTION OF UNINSTALLED ENGINES, PROPELLERS, HELICOPTER BLADES AND STORAGE DEVICES

3.1 GENERAL.

This chapter provides requirements for the preservation and storage inspection of uninstalled engines, propellers, helicopter blades and storage devices. Assets at Aerospace Maintenance and Regeneration Group (AMARG) may be stored on metal devices, wooden devices, in closed wooden containers or sealed metal containers.

3.2 UNINSTALLED ENGINE, HELICOPTER BLADE AND PROPELLER INDUCTION.

- a. Verify serial number of asset.
- b. Inspect shipping device and asset for obvious damage.
- c. Inspect storage device for corrosion, damage and functionality.
- d. Transfer asset from shipping device to approved storage device. (Applicable technical data.)
- e. Apply sprayable strippable coating and mark asset per Chapter 4. (Not required for metal or wooden containers.)
- f. Emboss a metal tag with Asset ID number and serial numbers of main and/or tail rotor blades stored inside container.
- g. Attach embossed metal tag to side of main and/or tail rotor blade container. Stencil AMARG container Asset ID per Paragraph 1.6.
- h. Place assets in AMARG approved storage location.

3.3 INSPECTION REQUIREMENTS.

Asset inspection interval is 360 days, unless a different interval is specified by the owning agency. Asset inspection requirements are listed in Table 3-1. Annotate any noted inspection discrepancies for correction.

3.3.1 Safe and Secure Check. A safe and secure check consists of a visual inspection of the storage device for obvious major deficiencies that require correction.

NOTE

Stored engines do not require preservation unless specified by the owning agency.

3.4 PRESERVATION OF STORED ENGINES.

Preserve engines per owning agency requirements.

3.5 SHIPPING ASSETS.

Prepare assets for shipment per the following.

- a. Verify serial number of asset.
- b. Prepare asset and records for shipment. (Applicable technical data or owning agency directed instructions.)

Table 3-1. Asset Inspection Requirements

Asset Type Storage Category	Engines					Props	Blades
	1000	1500	2000	4000	4500		
Asset Preservation (Paragraph 3.4.)	X						
Asset In Storage Inspection	Note 1						
Storage device inspection (Table 3-2.)	X	X	X			X	X
Storage device Safe and Secure Check (Paragraph 3.3.1.)				X	X		
Note 1: Inspect engine per owning agency guidance							

Table 3-2. Storage Device Inspection Requirements

Type Storage Device	Metal Device	Metal Container	Wooden Device	Wooden Container
Inspection Requirement				
Visible damage affecting functionality	X	X	X	X
Visible dry rot, stability, integrity, damage			X	X
Visible engine/propeller attachment points for security	X		X	
Sprayable strippable coating for damage, defects, general condition	X		X	X
Container position for drainage		X		X
Damaged/missing skids, hardware		X		
Pressurization		X		
Installed humidity indicator for color	X	X	X	
Identification stencil - legibility	X	X	X	X

CHAPTER 4 BARRIER SYSTEMS

4.1 PART A - PROCESS:

4.1.1 **General.** This chapter provides methods and procedures for preparation and application of sprayable strippable coatings and other barrier systems.

4.1.1.1 **General Guidance.** The following general guidance applies for application of sprayable strippable coating.

4.1.1.1.1 Do not apply tape when asset surface temperatures are less than 45 degrees Fahrenheit (°F) or greater than 125 °F.

4.1.1.1.2 Do not apply sprayable strippable coatings when winds are 16 knots or greater. Black Base Coat is thicker and will not disperse as easily and may be applied in winds up to 20 knots.

4.1.1.1.3 Do not apply tape or coatings to wet surfaces.

4.1.1.1.4 The applicable Sealing Diagram specifies the desired sealing pattern for each basic aircraft model or engine. Slight differences in aircraft configuration or condition may require additional filler materials, barrier materials, tape, or coatings to fully seal the aircraft.

4.1.1.1.5 Components removed from storage aircraft, where no specific sealing diagram exists, may have sprayable strippable coating applied using methods and procedures in this chapter.

4.1.2 **Coating Description.** Sprayable strippable coatings may be applied to metal, plastic, composite, and painted surfaces.

4.1.2.1 MIL-PRF-6799, Type II, Coatings.



MIL-PRF-6799, COATING, SPRAYABLE, STRIPPABLE, PROTECTIVE, WATER EMULSION

14

MIL-PRF-6799, Type II coatings consist of black (Class 1) base coat and a white (Class 6) top coat.

4.1.2.2 **Black Base Coat.** The black (Class 1) base coat may be used without a top coat for protecting surfaces for shipment.

4.1.3 **Equipment.** Table 4-1. lists the equipment used for the application of sprayable strippable coatings.

4.1.4 **Preparation of Surfaces for Application of Sprayable Strippable Coatings.** The following general guidance applies to the preparation of aircraft and components for the application of sprayable strippable coating. Follow the applicable Sealing Diagram for the aircraft to determine the placement of vents, locations for different release agents, filler materials, openings to be sealed, flight control sealing and other requirements.

Table 4-1. Application Equipment

Application Equipment
Atomizing spray equipment
Pneumatically agitated paint pot

Table 4-1. Application Equipment - Continued

Application Equipment
Air Compressor
Pressure regulator
Air/Water separator
Spray gun
Air hose
Material hose

4.1.4.1 Surface Cleaning.



TT-I-735, ISOPROPYL ALCOHOL

15



Isopropyl alcohol will damage canopy plastics and other plastics. Do not clean canopies or plastics with isopropyl alcohol. Failure to observe this caution may result in damage to aircraft.

Clean surfaces by wiping or blowing away dust and dirt. Remove any oily residue by wiping with a rag and isopropyl alcohol, TT-I-735.

4.1.4.2 Release Agents.



P-P-560, POLISH, PLASTIC

16



WAX, AIRCRAFT, WATERPROOF, SOLVENT TYPE, (FORMERLY MIL-W-18723), COMMERCIAL PURCHASE

17

Apply a thin even coat of Plastic Polish, P-P-560, aircraft waterproof wax (Formerly MIL-W-18723) or mold release, wax, water emulsion, P-W-155, to areas noted on sealing diagram. Allow to dry. Do not remove release agents prior to coating application. (Applicable Sealing Diagram.)

4.1.4.3 Vents and Drains. Install vents and drains. (Applicable Sealing Diagram.)

4.1.4.4 Filler Materials. Install filler materials (e.g. screen, cushioning material, tubes, desiccant etc.). (Applicable Sealing Diagram.)

4.1.4.5 Desiccant Suspension Devices. Install Desiccant Suspension devices (DSD). (Applicable Sealing Diagram.) Barrier material, MIL-PRF-131, Class 3, may be used if DSD is not available. Position barrier material shiny side down and place desiccant on barrier material.

4.1.4.5.1 Openings One Inch Width or Less, Any Length. Apply tape, AMS-T-22085, Type II, to seams, gaps, and open fastener holes, skin lap joints, and similar irregularities which may prevent the formation of a smooth uniform coating. See Figure 4-1. and Paragraph 4.1.5.

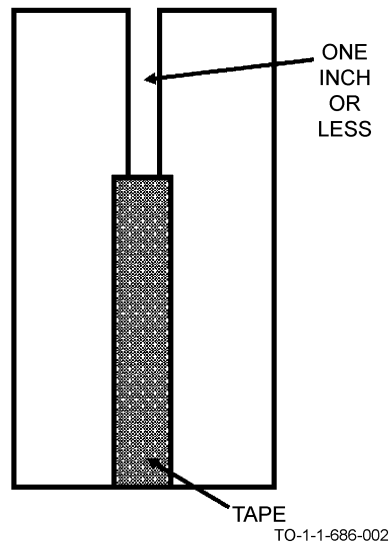

Figure 4-1. Tape Application

4.1.4.5.2 Openings Greater Than One Inch but Less Than 12 Inches. Close with barrier material, MIL-PRF-131, Class 3, and tape, AMS-T-22085, Type II. See Figure 4-2., Paragraph 4.1.5 and Paragraph 4.1.6.

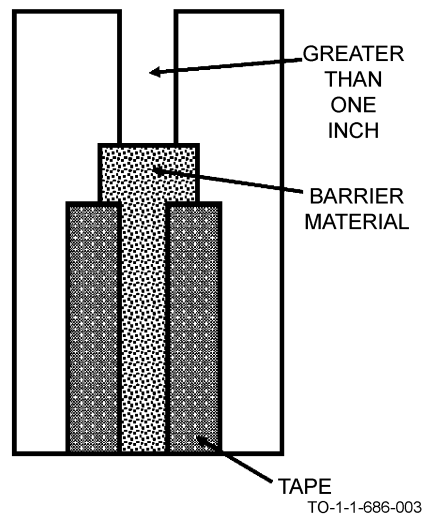

Figure 4-2. Tape and Barrier Material Application

NOTE

Engine intakes and exhausts, wheel wells, and other functional aircraft components or structures are not considered openings. Refer to the Applicable Sealing Diagram for sealing requirements.

4.1.4.5.3 Openings 12 Inches or Greater in Either Length or Width, or Any Non-Fastener Opening on Top of Asset. Close with fiberboard, ASTM D4727, held in place by tape, AMS-T-22085, Type II. Cover fiberboard, ASTM D4727, with barrier material, MIL-PRF-131, Class 3, held in place by tape, AMS-T-22085, Type II. See Figure 4-3., Paragraph 4.1.5 and Paragraph 4.1.6.

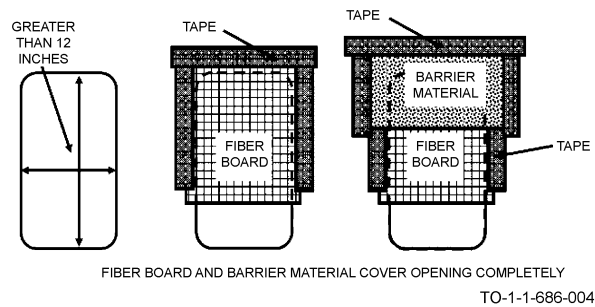

Figure 4-3. Sealing Openings Greater Than 12 Inches

4.1.4.6 Mask for Overspray. Mask areas for overspray per Paragraph 4.1.7.

4.1.4.7 Final Inspection Prior to Application of Coating.

- a. Inspect all installed material and tape for lifting and security prior to application of sprayable strippable coating.



TT-I-735, ISOPROPYL ALCOHOL

15

- b. Remove any tape that has lifted or is not secure. Wipe area with isopropyl alcohol, TT-I-735, and reapply tape, AMS-T-22085, Type II, prior to application of sprayable strippable coating.

4.1.5 Tape Application.

- a. Allow tape to relax after pulling from roll prior to application. Preservation tape will relax and separate from the surface if the tape is applied stretched.
- b. Cut tape cleanly from roll prior to application.
- c. Apply tapes as flat as possible, free of wrinkles, and creases. Use firm hand pressure for adhesion.
- d. Apply tape with a minimum of one inch overlapping the attaching surface.
- e. Make relief cuts in tape allowing tape to lie flat when applied to uneven or curved surfaces. See Figure 4-4.

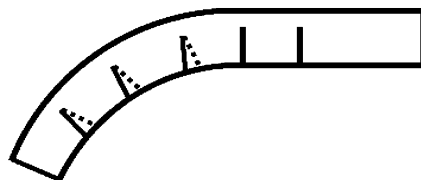

TO-1-1-686-005

Figure 4-4. Relief Cuts in Tape

- f. Apply tape starting at the bottom of a seam, place the next higher piece of tape over the lower tape in an overlapping pattern. See Figure 4-5.

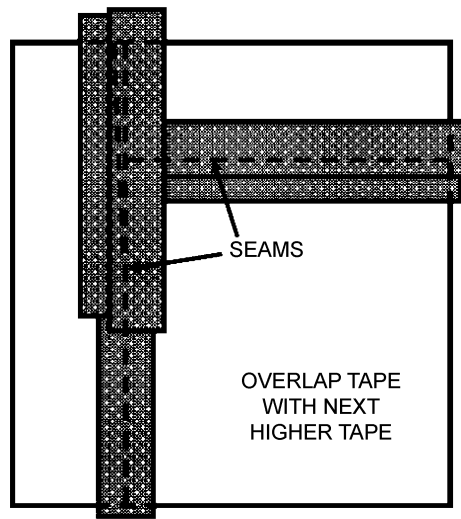

TO-1-1-686-006

Figure 4-5. Overlapping Tape Application

- g. Apply tape in an "X" pattern to bridge the gap between fixed and movable flight control surfaces. See Figure 4-6. "X" pattern minimum width is 16 inches to outside of end tapes.

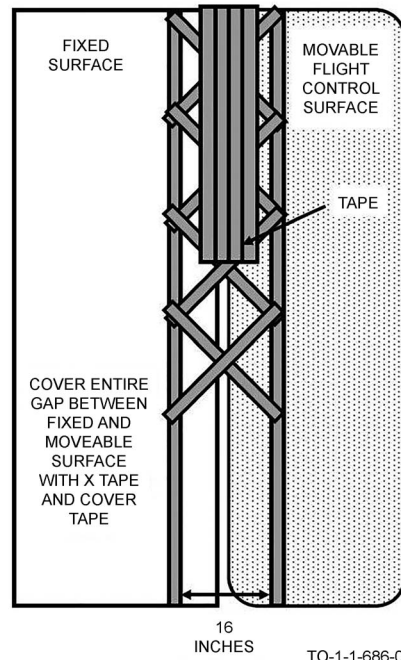

Figure 4-6. "X" Pattern for Control Surfaces



Cutting tape on aircraft surfaces may damage surface. Do not cut tape with knives on aircraft surfaces. Failure to observe this caution may result in damage to aircraft.

- h. Apply tape over sharp edges, such as trailing edges of wings and flight control surfaces to prevent breaks in the coating.
- i. Do not apply tape directly to special coatings such as inlet rain erosion coatings. Apply tape on painted surfaces near special coatings.

4.1.6 Barrier Material, Fiberboard and Vinyl Closures.

NOTE

- Barrier material, MIL-PRF-131, Class 3, will have the shiny side facing outward unless otherwise specified.
 - The word “material” in this section may refer to barrier material, MIL-PRF-131, Class 3, fiberboard, ASTM D4727, or vinyl closures (commercially procured).
- a. Cut material to extend a minimum of 1/2 inch beyond the edge of the area to be coated or covered.
 - b. Tack material with tape, AMS-T-22085, Type II, at corners or opposite sides to draw material tight.
 - c. Tape the edges starting at the bottom of the material and work upwards. Apply each piece of tape, AMS-T-22085, Type II, on top of the layer below.

4.1.6.1 Deteriorated or Unpainted Composite Surfaces. Apply barrier material, MIL-PRF-131, Class 3, secured with tape, AMS-T-22085, Type II, to deteriorated composite surfaces or composite surfaces with deteriorated paint.

4.1.7 Masking for Overspray.



Sprayable strippable coating overspray on transparencies, balanced control surfaces, and air inlets may affect pilot's visibility and degrade aircraft flight characteristics. Pay particular attention when masking off areas such as control surfaces, transparencies, engine inlets and propellers to prevent sprayable strippable coating overspray from affecting these areas. Failure to observe this caution may result in damage to aircraft.

NOTE

Only mask adjacent areas as required to protect from overspray.

- a. Mask surfaces adjacent to application area by applying any commercially available covering secured with tape, AMS-T-22085, Type II.
- b. Apply a final line of tape, AMS-T-22085, Type II, at the edge of the masked area.
- c. Remove masking materials after application of sprayable strippable coating.

4.1.8 Preparation of Sprayable Strippable Coatings.

4.1.8.1 Initial Agitation of Sprayable Strippable Coatings.

- a. Agitate material for a minimum of 4 minutes, three cycles for base coat and 4 minutes, two cycles for top coat. Remove lid after agitation and verify pigment is completely mixed.

- b. Agitate for additional cycles until pigment is completely mixed.
- c. Verify pigment is completely mixed prior to use.
- d. Base coat may be diluted with a maximum of 3 ounces of lukewarm water, per gallon of material.

4.1.9 Application of Sprayable Strippable Coating.

4.1.9.1 Black Base Coat.



MIL-PRF-6799, COATING, SPRAYABLE, STRIPPABLE, PROTECTIVE, WATER EMULSION

14

MIL-PRF-6799 Type II, Class 1.

- a. Clean surfaces by wiping or blowing away dust and dirt. Remove any oily residue by wiping with a rag and isopropyl alcohol, TT-I-735.
- b. Form a heavy bead around the edges of the application area. Form bead a minimum of one half inch beyond applied tape. Apply first coat 16 to 20 mils thick wet inside beaded area in a standard box coat fashion with one horizontal pass and one vertical pass.
- c. Measure film thickness with any commercially available wet film gauge.
- d. Allow a sufficient period of time to obtain a tack-free surface on the first base coat before applying the second base coat. The change from a glossy to a dull finish usually indicates a tack free surface.
- e. Clean previously sprayed surfaces that are dirty or disturbed. Blow with compressed air or wipe with clean rag prior to next coating application.
- f. Apply the second base coat using the same method as the first base coat.
- g. Allow the second base coat to dry to a tack-free surface before applying the white top coat.

4.1.9.2 White Top Coat.



MIL-PRF-6799, COATING, SPRAYABLE, STRIPPABLE, PROTECTIVE, WATER EMULSION

14

MIL-PRF-6799 Type II, Class 6.

NOTE

Dust coat may be applied before application of first top coat when temperature range is between 45° and 60° F.

- a. Clean previously sprayed surfaces that are dirty or disturbed. Blow with compressed air or wipe with clean rag prior to next coating application.
- b. Form a heavy bead around the edges of the area. Apply first base coat 8 to 12 mils thick wet inside beaded area in a standard box coat fashion with one horizontal pass and one vertical pass.
- c. Measure film thickness with any commercially available wet film gauge.

- d. Allow a sufficient period of time to obtain a tack-free surface on the first top coat before applying the second top coat. The change from a glossy to a dull finish usually indicates a tack free surface.
- e. Inspect coated surfaces for pinholes, holes, or breaks in the coating.
 - (1) Repair pinholes by applying a sprayed top coat.
 - (2) Repair holes, breaks and other discrepancies by applying brushable Kool Kote Mastic, KM101.
- f. Clean previously sprayed surfaces that are dirty or disturbed. Blow with compressed air or wipe with clean rag prior to next coating application.
- g. Apply the second top coat using the same method as the first top coat.
- h. Inspect the top coat for visible base coat or “shadowing”.
- i. Apply additional top coat(s) over the visible base coat until shadowing is no longer visible.

4.1.10 Repair of Existing Coated Surfaces. This procedure is used to apply sprayable strippable coating over existing applied sprayable strippable coatings. Do not repair coated surfaces more than four times. If area has been repaired four times, completely strip coating and apply new coating per Paragraph 4.1.9.

- a. Remove loose or damaged coating per Paragraph 4.1.13.
- b. Clean surface per Paragraph 4.1.4.
- c. Prepare aircraft surfaces using steps listed in Paragraph 4.1.4.
- d. Apply tape per Paragraph 4.1.5.
- e. Apply two base coats and two top coats per Paragraph 4.1.9.

4.1.11 Repair of Eroded Top Coat.

- a. Clean surface per Paragraph 4.1.4.
- b. Apply two top coats per Paragraph 4.1.9. over existing eroded top coat.

4.1.12 Marking.

- a. Stencil Aircraft Identification Number per Paragraph 1.6. after final top coat.
- b. Stencil coated engine or enclosed storage device with Engine Type Model Series, Engine Serial Number and AMARG Asset ID per Paragraph 1.6.
- c. Stencil sealed or coated propeller or storage device with Propeller Serial Number and AMARG Asset ID per Paragraph 1.6.
- d. Reapply any stencils listed in Table 1-2. that were covered by sprayable strippable coating.
- e. Stencil covered opening(s) on top of asset with “DO NOT STEP – FIBER BOARD” per Paragraph 1.6.

4.1.13 Removal of Sprayable Strippable Coatings.

CAUTION

Damage to aircraft surfaces may occur if sharp or metallic tools are used to remove sprayable strippable coatings. Do not use sharp or metallic hand tools to remove coating. Failure to observe this caution may result in damage to aircraft.

NOTE

Sprayable strippable coating can be removed by any means necessary when accomplishing procedures in Chapter 9.

- a. Separate an edge of the sprayable strippable coating from the aircraft surface. Use a non-metallic scraper.
- b. Work the coating back and forth by hand. Use a side to side motion and peel coating back from the free edges.
- c. Use a non-metallic scraper to loosen areas that require additional effort for removal from the surface.
- d. Monitor the aircraft surface during removal. If aircraft surface is damaged, stop removal operations and report damage to supervision.
- e. Contact the owning agency if coatings cannot be removed by the above method.

4.1.14 Cutting Sprayable Strippable Coating.

CAUTION

Aircraft surfaces may be damaged if sprayable strippable coating is cut from surfaces. Do not cut sprayable strippable coatings directly on aircraft surfaces. Only cut coating along panel seams or other mating surfaces. Failure to observe this caution may result in damage to aircraft.

NOTE

Sprayable strippable coating can be cut on any aircraft surface when accomplishing procedures in Chapter 9.

Carefully cut sprayable strippable coating with utility knife or similar cutting devices along panel seams or other mating surfaces for access.

4.2 PART B - SHRINK WRAP PROCEDURES.

4.2.1 Shrink Wrap.

CAUTION

Shrink wrap tape will not release from asset surfaces and may damage the surface. Do not apply shrink wrap tape to asset surfaces. Failure to observe this caution may result in damage to aircraft.

- a. Apply cushioning material, Surlyn 9720 or A-A-59136, Class 1, Type I, Grade A, to exposed sharp edges of asset.
- b. Apply fiber board material, ASTM D4727, to openings greater than 12 inches and secure with tape, AMS-T-22085, Type II.
- c. Apply shrink wrap, 14-200-7W or equivalent, to lower surface extending upward on asset and secure edges with tape, AMS-T-22085, Type II.

- d. Apply shrink wrap, 14-200-7W or equivalent, to upper surface extending downward and overlapping lower shrink wrap and secure with shrink wrap tape, 15D065 or equivalent.
- e. Apply additional shrink wrap, 14-200-7W or equivalent, as required to cover entire asset, overlapping existing shrink wrap.
- f. Apply shrink wrap tape, 15D065 or equivalent, to all overlapping shrink wrap seams.

4.3 PART C - SEALING DIAGRAM DEVELOPMENT PROCESS.

4.3.1 Purpose. The purpose of the Aircraft Sealing Diagram is to identify locations that require coating or sealing and specify the required materials to coat or seal and ventilate an aircraft, engine or component. Sealing an aircraft prevents water intrusion, accumulation of dust and dirt, minimizes animal or insect intrusion and protects surfaces that would be damaged by airborne contaminants and abrasives.

4.3.2 Sealing Diagram Development. The following general procedures are used to develop Sealing Diagrams. Sealing Diagrams are developed and managed by the primary owning agency with engineering authority for the system. The primary owning agency will approve the current Sealing Diagram for aircraft used by multiple agencies (e.g. C-130). The owning agency for a specific aircraft may add additional coating or sealing criteria for the specific aircraft.

- a. Identify crew station and crew entry door sealing based on the aircraft configuration.
- b. Identify locations for vinyl closures to allow access at door or window locations.
- c. Identify crew station ventilation method. Ventilate aircraft crew stations by utilizing existing buried or protected access openings such as those located in wheel wells, access plates, valves, etc. Identify if a ventilator tube or plate will be installed.
- d. If buried or protected access openings cannot be used, for aircraft having sliding or raising canopies, specify to open canopies sufficiently to install a ventilator tube. Specify the ventilator tube should fit snugly in opening and have nozzle directed downward. Specify to seal all openings around the canopies.
- e. If buried or protected access openings cannot be used and canopy does not slide or raise to open, specify to open a window on each side of the cockpit and install one ventilator tube in each window. Specify the ventilator tube should fit snugly in opening and have nozzle directed downward. Specify to seal all openings around the windows.



P-P-560, POLISH, PLASTIC

16

- f. Identify transparent acrylic windows and canopies to be coated. Specify method and coating for transparent acrylics. Standard covering for transparencies is polish, P-P-560 and sprayable strippable coating. Alternate protection is a sequence of polish, flannel cloth, barrier material and sprayable strippable coating.
- g. Identify openings above the drip line of the aircraft which would allow water intrusion. Specify the required sealing method for these areas.
- h. Identify large openings to be covered with barrier material or fiber board secured with tape and covered by sprayable strippable coatings.
- i. Identify small openings to be covered with tape and sprayable strippable coating.
- j. Identify openings below the drip line of the aircraft, larger than 3/8 of an inch, which would allow animal or insect intrusion. Specify cushioning material or screen to close these areas. Screen should not be used where dust and dirt intrusion can affect internal areas of the aircraft which cannot be easily cleaned.

- k. Specify location of sealed areas on lower airframe that require a minimum of two, 1/4 inch holes punctured through the sealed area to prevent water entrapment and allow venting.
- l. Identify internal passageway doors. Specify if doors are to be opened for interior breathing.
- m. Identify if aircraft is compartmentalized with no doors or passageways that allow free breathing. Identify locations in each closed compartment for ventilator tubes to a ventilated compartment or the outside of the aircraft. Specify location for ventilator tube installation for each identified compartment.
- n. Identify all static pressure ports, instrument filter inlets, outlets and breathers. Specify static port vents for these locations.
- o. Identify Pitot tube locations. Specify cover to be used and secured with safety wire.
- p. Identify fuel system vents. If fuel system vents are located in a manner that would allow water, dirt or animal entry, specify extension tubes to be installed and appropriate sealing. Otherwise, specify vents to be left open for breathing.
- q. Identify gun ports, lightning holes or other openings that expose internal compartments or equipment to the outside. Specify sealing method for these locations.
- r. Identify cartridge case ejection ports. Specify sealing method for these locations.
- s. Identify glass and transparent acrylics (non-canopies, e.g. lights) that need to be coated. Specify the treatment and coating method for these areas. Lights on lower aircraft surfaces do not typically get coated, unless damage might occur due to airborne abrasive action.
- t. Identify photographic system windows, lens, and exterior viewfinders. Specify a treatment and coating method for these areas.
- u. Identify radomes and other reinforced plastic surfaces. Specify a treatment and coating method for these areas.



WAX, AIRCRAFT, WATERPROOF, SOLVENT TYPE, (FORMERLY MIL-W-18723), COMMERCIAL PURCHASE

17

- v. Identify decals, stencils, neoprene, and rain erosion resistant material coated surfaces to be protected. Standard method is to coat with aircraft waterproof wax (Formerly MIL-W-18723).
- w. Specify covering and sealing method for helicopter rotor heads. Standard covering for rotor heads is fabricated from fiber board, barrier material and tape. Commercial rotor head cover may be used. When using rotor head cover, specify to pad all sharp and protruding surfaces with cushioning material, secured with tape. If required, specify cover to be secured to rotor heads using nylon cord, to prevent loosening of barrier material by wind buffeting. Specify overboard drain and vent locations to prevent water accumulation.
- x. Identify any components that will be removed prior to coating. Specify the appropriate method to seal the area after removal of the component, (e.g. caps, plugs, etc.).
- y. Identify engine sealing. Specify sealing methods for the external intake and exhaust areas.
 - (1) The interior of the engine itself should be sealed, including drains and vents, and desiccant added to ensure the interior of the engine is in a dehydrated environment. A secondary seal inside the intake and exhaust may be required to completely seal the interior of the engine. The nacelle or engine bay should be vented to atmosphere and allowed to breath and drain.
 - (2) Specify amount of desiccant (if required) to be installed prior to sealing. Standard desiccant is MIL-D-3464, Type I. Desiccant amount can be estimated by $U=1.6KV$. U = amount of desiccant. $K=0.0007$. V = approximate volume of engine bay in cubic inches. Specify half of the total desiccant in the intake and half in the exhaust.

- (3) Identify engine overboard drains and vents from the inside of the engine. Specify plastic caps, or plugs, or barrier material and sprayable, strippable coatings for these areas.
- z. Identify engine nacelle and bay openings to the fuselage or nacelle that are above the horizontal centerline of the engine and may allow water to enter. Specify sealing method for these areas.
- aa. Identify engine nacelle and bay drain areas that should remain open.
- ab. Identify propeller deicer boots. Specify preparation and coating. Standard coating is mold release, wax, water emulsion, P-W-155, and sprayable, strippable coating over the deicer boots.
- ac. Identify propeller areas to be sealed.
- ad. Specify location of permanent drains that should be left open and free of obstructions after aircraft sealing.

4.3.2.1 Aircraft Covers.



MIL-PRF-6799, COATING, SPRAYABLE, STRIPPABLE, PROTECTIVE, WATER EMULSION

14

Material MIL-P-58102, may be used instead of MIL-PRF-6799, for sealing aircraft as approved by owning agency for specific application. Aircraft covers may be full length or a top cover. A top cover is defined as an aircraft cover that covers the upper portion of the aircraft to the drip line. Specify cover to be used, if applicable.

4.3.2.2 Sealing Diagram. A sealing diagram typically has two sections and a table. The first section identifies the sealing materials by location. See Figure 4-7. The second section is an illustration with numbered reference locations on the aircraft. The table identifies the locations which are sealed for different Storage Types. See Figure 4-7. AMARG will provide an example Sealing Diagram at owning agency request.

4.3.2.2.1 See Table 4-2. for coating and sealing materials and specifications. Use the reference letter in the Sealing Diagram to specify the material to be used.

Table 4-2. Sealing Materials and Specifications

Letter(s)	Material
B	Barrier material (MIL-PRF-131, Class 3)
P	Plastic polish (P-P-560) (Tex-Whiz, PN 5602260, TEXSTAR – commercial)
SW	Aircraft wax, water proof (Commercial purchase). (Formerly MIL-W-18723)
T	Tape, sealing/preservation (SAE AMS-T-22085, Type II) (3M 481).
S	Coating, sprayable, strippable (MIL-C-6799, Type II, Class 1 & 6).
CC	Kool Kote mastic (P/N KM101)
CP	Corrosion preventive compound (MIL-PRF-16173, Grade 1, 2 or 4) (Grade to be specified on Sealing Diagram)
CM	Cushioning material (Surlyn 9720).
CMW	Closed cell polyethylene cushioning material, white. (A-A-59136.) Alternate material to be used for CM.
FI	Fiberboard (ASTM D4727).
MR	Mold releasing agent, wax (P-W-155).
V	Ventilator tube (AMARG DWG X20178451) or plate (AMARG DWG X20178452). Specify tube or plate.
D	Desiccant (MIL-D-3464, Type 1).
SC	Screen (L-S-125, Type II, Class 1).
IA	Isopropyl Alcohol (TT-I-735).

Table 4-2. Sealing Materials and Specifications - Continued

Letter(s)	Material
PTC	Pitot Tube Cover
SPV	Static Port Vent
AAC	Angle of Attack probe cover (AMARG DWG X201443010)
SFW	Safety Wire
DSD	Desiccant Suspension Device
PT	Polyethylene tubing, commercial grade.
FLC	Flannel Cloth (used to cover canopy surfaces prior to application of barrier materials or covers on canopy.
PS	Plastic Sheet. (Commercial).

4.3.3 Sealing Diagram Prototype Test. Sealing Diagram development shall include a prototype and water spray test for each type and model. The prototype water test will be accomplished once for each type and model to validate the Sealing Diagram. Each series will be examined to determine if prototyping is necessary. Water test shall be completed on the prototype aircraft after final application of sprayable strippable coating and prior to final storage. All defects found after water spray test shall be corrected.

4.3.3.1 Sealing Diagram Prototype Testing.

- a. Coat and seal the aircraft per the prototype Sealing Diagram.
- b. Inspect the coated and sealed aircraft for defects in sealing materials and repair as required.
- c. Allow the coatings to fully dry.
- d. AMARG Process Engineering will identify areas to be opened and examined for water entry. Annotate the prototype Sealing Diagram for identified areas.
- e. Connect a standard size water hose to domestic water service and direct water onto the aircraft surfaces and sealed areas.
- f. Direct water flow downward on sealed areas as much as practicable so that water flows from unsealed aircraft surfaces onto sealed surfaces.
- g. Pan the water stream along all seams between uncoated and coated surfaces until all perimeters of coated surfaces have been thoroughly wetted.
- h. Stop water flow and allow aircraft to dry. Wipe dry any accumulations of water on aircraft surfaces.
- i. AMARG Engineering and sealing crew will cut through sealing materials in areas identified previously. Do not peel the coating seams away from aircraft surfaces.
- j. Examine aircraft areas under removed sealing materials to determine if water entry has occurred. Perform the following if water is found under removed sealing materials:
 - (1) Trace any leaks to a suspected point of water entry.
 - (2) Evaluate the Sealing Diagram method and materials for sealing the area and annotate the prototype Sealing Diagram with a modification to correct the source of water entry.
- k. Recoat or reseal the area(s) using the proposed modification and allow the coatings to dry.
- l. Repeat the wetting procedures on any resealed areas. Allow aircraft to dry.

- m. Repeat the water entry examination for retested areas.
 - n. Repeat the wetting and examination process until all areas show no water entry.
 - o. Strip all areas examined for water intrusion and recoat or reseal aircraft per the annotated Sealing Diagram.
- 4.3.3.1.1 Provide the owning agency with the prototype water test results and annotated updates to the Sealing Diagram.
- 4.3.3.1.2 The owning agency will update the Sealing Diagram and release the approved Sealing Diagram to AMARG.

1. (T&S) Pitot tube, Install support cover.
2. (AAC, T&S) Angle of attack probe. Install cover secured with (T&S).
3. (AAC, T&S) Air Data Probe, as applicable, depending upon model.
4. Cockpit sealing Instructions are as follows:
 - a. Open panel #2101.

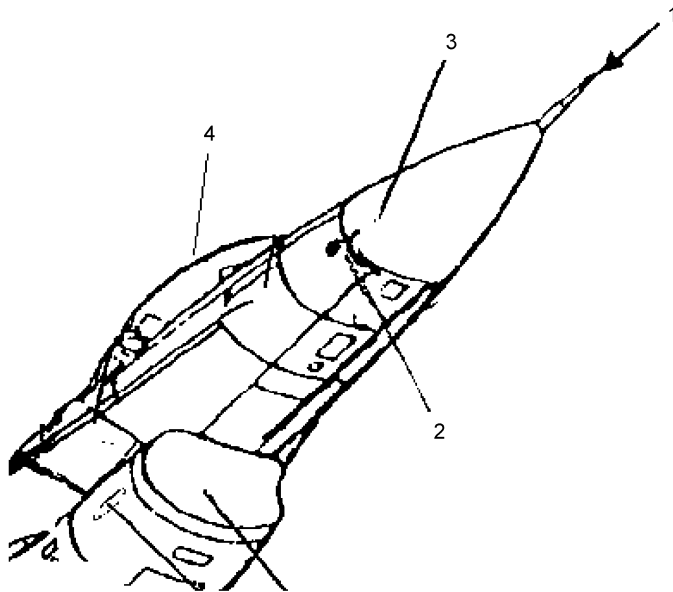

TO-1-1-686-008

Figure 4-7. Sealing Diagram Elements (Example)

CHAPTER 5 RECLAMATION

5.1 GENERAL.

This chapter contains procedures for performing reclamation actions on assets or equipment in storage.

- a. Perform Safe for AMARG Desert Operations per Chapter 1 prior to performing parts reclamation.
- b. Drain, cap, plug or cover all disconnected fluid lines and electrical connectors on parts removed for reclamation actions. This applies to the requested part and adjacent parts removed for access. Cover electrical connectors with plastic caps or cover and seal connector using electrical insulation tape, A-A-59163, Type II.



Moisture may collect inside plastic bags and corrode connectors. Do not use plastic bags on electrical connectors. Use only plastic caps or electrical tape to cover electrical connectors and devices. Failure to observe this caution may result in damage to aircraft.

- c. Drain, cap, plug or cover all disconnected fluid lines and electrical connectors on aircraft that were disconnected for reclamation actions. Cover electrical connectors with plastic caps or cover and seal connector using electrical insulation tape, A-A-59163, Type II.

NOTE

Alternate equipment may be used to perform reclamation tasks when the required equipment is unavailable as long as the task can be safely accomplished and no damage to components or equipment will occur.

5.2 PARTS RECLAMATION PROCEDURES.



Some Reclamation operations may cause the center of gravity of an asset to change which may cause asset to tip, shift or fall. Review the AMARG specific Safety Summary for additional information. Failure to observe this warning may result in death or injury to personnel.



Aircraft not supported by wheels and tires and structurally complete landing gear may shift or collapse. Do not remove wheels and tires, landing gear assemblies or components from unsupported aircraft. Failure to observe this caution may result in damage to aircraft.

- a. Assess center of gravity condition of aircraft or asset to account for possible shifts in center of gravity during reclamation actions.
- b. Remove adjacent parts to gain access to the requested part(s).
- c. Dispose of removed common attachment hardware (e.g. nuts, bolts, washers, spacers, etc.) from requested part, unless hardware is requested by the owning agency.
- d. Temporarily install removed adjacent part(s) per Chapter 1.

- (1) Place remaining attachment hardware in a bag, and attach to the removed adjacent part.
 - (2) If removed adjacent part cannot be temporarily installed, tag part and place on aircraft as close as possible to original location.
 - (3) If removed adjacent part cannot be placed on aircraft, tag part and place in a storage container.
 - (4) If removed adjacent part is too large for storage in aircraft or container, (e.g. wings, fuselage section, etc.), tag part and place on pallet, storage fixture or device. Secure large components per Chapter 7.
- e. Close or secure aircraft canopies, windows, doors, aircraft covers, etc. opened for part removal. Temporarily apply tape, AMS-T-22085, Type II, if area was originally covered with sprayable strippable coating.
- f. Temporarily install removed panels per Chapter 1.

NOTE

Contact part requester for guidance when disconnected control surface and lift device components cannot be secured after part removal.

- g. Secure disconnected control surfaces, leading edge devices, trailing edge devices if moved or repositioned for part removal or inspection.
- h. Wrap exposed landing gear axles in barrier material, MIL-PRF-131, Class 3, and tape, AMS-T-22085, Type II, when wheel and tire assembly will not be placed back on aircraft axle. Wrap wheel bearings in barrier material, MIL-PRF-121, Type I, and place in locking plastic bags for storage.
- i. Complete the following when reclaiming or removing aircraft engines or propellers:
- (1) Verify correct engine or propeller serial number prior to removal.
 - (2) Place removed engine or propeller on storage or shipping fixture.
 - (3) Tag engine or propeller with serial number after removal.
 - (4) Wrap engine or propeller to prevent moisture intrusion. (Applicable technical data.)
 - (5) Store engine or propeller per owning agency guidance.

5.3 SEALING ASSETS AFTER PART RECLAMATION.

Apply sprayable strippable coating per Chapter 4 to aircraft or stored components to cover all opening(s) created by part reclamation not covered by panel(s). Apply sprayable strippable coating per Chapter 4 over all opened areas that were previously coated.

5.4 AIRCRAFT STRUCTURAL CUTS.

WARNING

- Structural cuts create heat and flying debris. Personnel will use the required Personal Protective Equipment (PPE) when performing aircraft cut operations. Injury to personnel may occur if proper PPE is not utilized.
- Structural cuts may cause the center of gravity of an asset to change which may cause asset to tip, shift or fall. Review the AMARG specific Safety Summary for additional information. Failure to observe this warning may result in death or injury to personnel.

CAUTION

Damage to aircraft and equipment may occur if aircraft is left in an unsupported configuration after cutting operations. Do not leave aircraft in an unsupported condition. Failure to observe this caution may result in damage to aircraft.

NOTE

- Components will be removed per applicable technical data, unless owning agency approves alternate methods.
 - Major structural cuts are specific to the aircraft condition, owning agency request and other factors. The information and procedures provided in this section will be used in conjunction with appropriate Risk Management (RM), or Job Safety Analysis (JSA) activities to address specific aspects of each cut.
 - Contact owning agency for sealing requirements after major structural cuts to asset remaining in storage at AMARG.
- a. Identify structural cut locations.
 - b. Assess center of gravity condition of aircraft or asset to account for possible shifts in center of gravity during or after aircraft cutting.
 - c. Support aircraft for cutting operations.
 - d. Drain all fluids in vicinity of cut area.
 - e. Remove fluid lines, cables, wiring and any other component from cut area.
 - f. Remove substructure from cut area.
 - g. Set up safety perimeter.
 - h. Notify Control of pending cut.
 - i. Task Supervisor shall give a safety briefing and may review RM or JSA with all personnel involved prior to starting cutting operations.
 - j. Perform aircraft cut.
 - k. Notify Control when cutting operations are completed.
 - l. Store large aircraft sections (e.g. wings, fuselage section, etc.) on pallets, storage fixtures or devices. Secure sections per Chapter 7.

CHAPTER 6

DEPRESERVATION FOR RECURRING PRESERVATION

6.1 GENERAL.

This chapter provides instructions for depreservation of aircraft for recurring preservation. Preservation procedures may be accomplished in conjunction with depreservation procedures. Perform aircraft records review prior to performing aircraft depreservation.

6.2 DEPRESERVATION.

6.2.1 Preparation for depreservation.

- a. Remove all coating and sealing materials from aircraft exterior per Chapter 4.
- b. Remove gust locks (Applicable technical data.) or battens from all control surfaces.
- c. Remove desiccant and desiccant suspension devices from engine inlets and exhaust. Inspect inlets and exhaust for foreign objects.
- d. Perform pre-power application safety check.
 - (1) Remove barrier material and tape from electrical system components.
 - (2) Inspect visible interior electrical wiring and connectors for corrosion and damage.
- e. Install dry cell batteries required to apply aircraft power and perform on-aircraft engine run-up or motoring.
- f. Install wet cell batteries required to apply aircraft power and perform on-aircraft engine run-up or motoring.
- g. Complete aircraft wash and lubrication requirements per Chapter 2.
- h. If applicable, clean canopy seals per Chapter 1.
- i. Perform a general interior vacuuming of the aircraft flightdeck or cockpit per Chapter 1.
- j. Clean aircraft interior of any visible oily or greasy deposits per Chapter 1.
- k. Remove non-serviceable interior preservation materials.

6.2.2 Fuel System Depreservation. The following procedures are for depreservation of the aircraft fuel system. If the aircraft fuel system is not operable, contact owning agency for guidance.



MIL-PRF-6081, LUBRICATING OIL, JET ENGINE

8

- a. Open all fuel system drains including low point drains. Remove as much MIL-PRF-6081, preservation oil as possible from fuel systems. Close all drains.
- b. Service aircraft with sufficient fuel for fuel system and engine operation. (Applicable technical data.)

- c. Operate fuel transfer system (Applicable technical data.) to fill entire fuel system (including lines, valves, and pumps) and air refueling systems with fuel.
- d. Depreserve engines.

6.2.3 Aircraft Power Plant Depreservation. Depreserve engines and Auxiliary Power Units (APU) by operational depreservation method. Engines that cannot be depreserved by the operational method may be depreserved by the alternate motoring depreservation method. Engines preserved by cold preservation do not require depreservation.

6.2.3.1 Preparation.

- a. Prepare aircraft and engine(s) for engine run. (Applicable technical data.)
- b. Drain tanks and sumps and service engine fluids.
- c. If aircraft has turbo-prop engines, drain and service self-contained pitch change mechanisms. (Applicable technical data.)
- d. Clean aircraft and engine actuator rods that will be actuated during on-aircraft engine run.
- e. Check hydraulic system servicing. Service if required. (Applicable technical data.)
- f. Open engine fuel feed valve(s). (Applicable technical data.)

6.2.3.2 Operational Depreservation Method.

- a. Start and operate turbojet or turbofan engines at 70-80 percent normal rated speed, turboprop engines at ground idle settings. Run engines for a minimum of five minutes. Turbo prop aircraft transmissions and gearboxes are depreserved during the engine operational depreservation procedure.
- b. Shut down engine(s) using normal shutdown procedures. (Applicable technical data.)
- c. Start and operate APU at no load condition for a minimum of five minutes. (Applicable technical data.)
- d. Shut down APU using normal shutdown procedures. (Applicable technical data.)

6.2.3.3 Alternate Motoring Depreservation Method.

- a. Deactivate the engine ignition system. (Applicable technical data.)
- b. Place throttle at idle. Motor the engine with the fuel feed valve(s) open. (Applicable technical data.) Motor the engine for the equivalent of two starting cycles using the starter (observe starter duty cycle limitations).
- c. Place throttle at cut-off and close engine fuel feed valve(s). (Applicable technical data.)

6.2.4 Helicopter Transmission and Gearbox Depreservation. AMARG will not operate helicopter transmissions and gearboxes per applicable technical data. Hand rotation or motor-over rotation will be utilized in place of operation of helicopter transmissions and gearboxes in applicable technical data.

- a. Drain fluid from transmissions and gearboxes. Service to normal operating level with operating lubricant. (Applicable technical data.)
- b. Hand rotate turbo shaft helicopter transmissions and gearboxes for a minimum of ten revolutions.

CHAPTER 7

AIRCRAFT TOWING AND MOORING

7.1 GENERAL.

This chapter contains towing and mooring procedures for Type 1000, 1500, 2000 and 4000 storage aircraft. Aircraft in Type 1000, 1500, 2000 and 4000 storage can be towed on unprepared surfaces which may include dirt, crushed asphalt, gravel, AM-2 matting or corrugated matting. Aerospace Maintenance and Regeneration Group (AMARG) may use aircraft debogging equipment and procedures in Technical Order (TO) 00-80C-1 if required. Ballast may be required for towing or storage due to aircraft condition. AMARG storage aircraft may have major components removed. Contact AMARG Engineering or owning agency for ballast or aircraft movement requirements. For towing purposes all aircraft inducted into AMARG for storage will be considered stored aircraft at the time of their arrival at DMAFB.

7.2 GENERAL TOWING INSTRUCTIONS.

7.2.1 Alternate Tow Bars. Alternate tow bars listed in Table 7-1. may be used on the listed aircraft.

Table 7-1. Approved alternate tow bars.

Aircraft		Alternate Tow Bar		
MDS	Variant	Special Adapter Required	MD-1	NT-4
C-23	All	No	No	Yes
C-27	A	No	No	Yes
C-27	J	No	Yes*	Yes
F-100	F	No	Yes	No
C-20	All	X20151003	Yes	No

* Indicates tow bar attachment jaw opening downward

7.2.2 Tow Team. An AMARG tow team will consist of the following minimum personnel: Tow Team Supervisor, Tow Vehicle Operator, and two Tow Team Members. Additional personnel may be required.

7.2.2.1 Tow Team Supervisor.

- Will determine when chock walkers will perform dual responsibilities as wing and chock walker.
- Will determine if a tail or wing walker is required for backing aircraft when not defined in technical data.
- Will determine if chock walkers are required for towing aircraft on inclines.
- Notify Tow Section Supervisor if aircraft is not safe for servicing or towing operations.

7.2.2.2 Tow Vehicle Operator.

- Will be fully qualified and licensed to drive the tow vehicle.
- Will follow the directions provided by the Tow Team Supervisor.

7.2.3 AMARG Towing Operations. Towing operations at AMARG are categorized into two types:

- a. When towing operations are required this technical order will be utilized in conjunction with MDS specific technical orders as applicable.

WARNING

All personnel requiring cockpit access during the towing operation shall have completed the applicable emergency ground escape course. If an operational egress system is installed, the applicable egress familiarization course shall be completed and current. Before opening canopies check MDS applicable technical data for wind speed limitations. Failure to observe this warning may result in serious injury or death to personnel.

- b. Desert safe for maintenance will be performed on aircraft that have been stenciled with the GREEN CROSS symbol or RED WARNING stencil (See Chapter 1). For aircraft without the stencil safe for maintenance MDS specific technical data will be used.
- c. All storage category aircraft may be chock walked if brake rider is not present, cockpit is inaccessible, weather conditions make it unsafe, or brake system cannot be serviced.
- d. Inspect aircraft for missing/unsecured panels, if found, review MDS specific technical data for panel securing requirements.

7.2.4 Towing on Prepared Surfaces.

WARNING

Tires on storage aircraft may catastrophically fail due to deteriorated condition and increased heat and stress during aircraft towing. Tire failure may result in flying tire debris. Review the AMARG specific Safety Summary for additional information. Failure to observe this warning may result in death or injury to personnel.

NOTE

- Chock walkers may also perform wing walker duties for aircraft with less than 75 foot wingspan. See Figure 7-2. for wingspan identification.
 - Wing walkers and tail walkers are not required on unobstructed established taxiways, runways, and parking ramps where taxi or towing lines are marked with guide lines.
- a. Position a minimum of one chock walker on the left and right side, outboard of aircraft main gear, when any part of the towed aircraft is within 10 feet of another aircraft or an obstruction. Each chock walker will remain within a semi-circle formed by the nose, wing tip and tail of the towed aircraft. See Figure 7-1.
 - b. Each chock walker will carry or drag one chock while chock walking.
 - c. Position a wing walker near each wing tip when any part of the towed aircraft is within 25 feet of another aircraft or an obstruction.
 - d. Position a tail walker near the tail of an aircraft that is being pushed backwards or towed into a hangar or shelter.

7.2.5 Towing on Unprepared Surfaces.

WARNING

Tires on storage aircraft may catastrophically fail due to deteriorated condition and increased heat and stress during aircraft towing. Tire failure may result in flying tire debris. Review the AMARG specific Safety Summary for additional information. Failure to observe this warning may result in death or injury to personnel.

NOTE

Chock walkers may also perform wing walker duties for aircraft with less than 75 foot wingspan. See Figure 7-2 for wingspan identification.

- a. Position a minimum of one chock walker on the left and right side of the aircraft (outboard of aircraft main landing gear) when any part of the aircraft in tow (fuselage, wings, empennage) is within 10 feet of another aircraft or an obstruction (see Figure 7-1). When A/C is not within 10 feet of another aircraft or an obstruction, each chock walker may ride in vehicles positioned at the left- and right-wing tip with chocks readily available.
- b. Each chock walker will carry or drag one chock while chock walking.
- c. Chock walkers may be used for towing aircraft on inclines.
- d. Position a wing walker near each wing tip when any part of the wing section of the towed aircraft is within 10 feet of another aircraft or an obstruction.

- e. Position a tail walker near the tail of an aircraft that is being pushed backwards when any part of the tail section of the towed aircraft is within 10 feet of another aircraft or an obstruction.

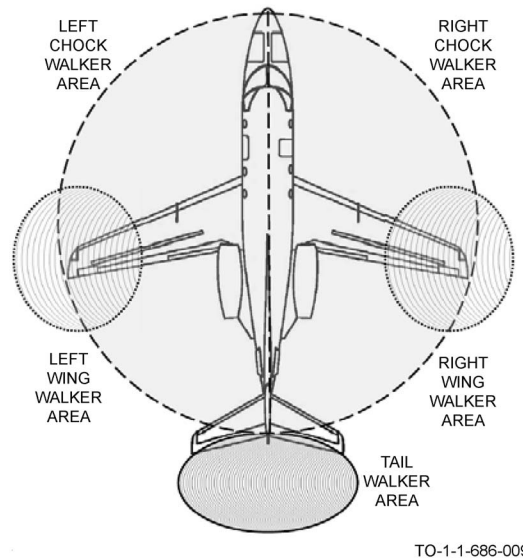

Figure 7-1. General Chock, Wing and Tail Walker Areas

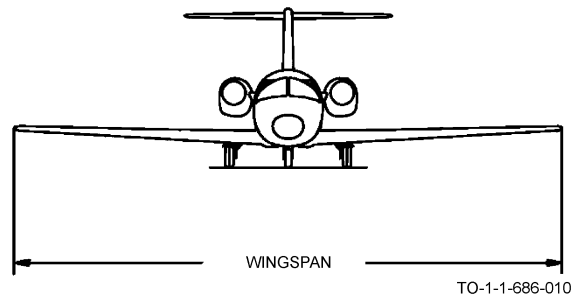

Figure 7-2. Aircraft Wingspan

7.3 STORAGE AIRCRAFT TOWING PROCEDURES.

NOTE

Notify Tow Section Supervisor if aircraft is not safe for servicing or towing operations.

7.3.1 Preparation for Towing. Perform the following steps prior to moving aircraft:

- a. Assess ground surface conditions around aircraft and along tow path.
- b. Perform aircraft safe for Desert Operations per Chapter 1.



Aircraft landing gear with missing components may collapse during towing operations. Do not tow an aircraft with missing landing gear components. Failure to observe this caution may result in damage to aircraft.

- c. Inspect landing gear struts for missing and damaged components that would prevent aircraft from being safely towed, (e.g. drag links or down lock braces etc.).

A rectangular box with a black background and white border containing the word "WARNING" in bold, uppercase letters.

WARNING

Overservicing of aircraft struts may cause the strut to rupture and fail. Observe applicable technical data limits for maximum servicing pressure and extension. Failure to observe this warning may result in death or injury to personnel.



A-A-59503, NITROGEN

19

NOTE

- Based on aircraft configuration and center of gravity, aircraft nose gear may be serviced to half normal operating height to improve towing characteristics.
 - Some aircraft may require that tire servicing is performed prior to strut servicing. The order of steps may be changed for these aircraft.
- d. Visually inspect the strut to verify that polished chrome of the strut is exposed. Visually verify that the length of the polished chrome surface exposed is between the minimum and maximum allowable values of X as defined on the strut data plate. If required, service the strut with nitrogen, A-A-59503, to desired length. (Applicable technical data.)

NOTE

The pressure values corresponding to dimension X listed on the strut data plate are not applicable for desert towing operations.

- e. If no strut movement occurs by 75 percent of maximum pressure, stop nitrogen servicing. Deplete strut pressure. Perform hydraulic strut servicing. (Applicable technical data.)
- f. Inspect and service tires per Paragraph 7.4.
- g. Perform tow team briefing.
- h. Disconnect tow bar from tow vehicle.
- i. Inspect tow bar as follows:
 - (1) Inspect shear bolts for evidence of shearing. Replace shear bolts where shearing evidence is noted prior to using tow bar.
 - (2) Inspect locking mechanism for proper operation.
 - (3) Inspect overall tow bar for any general damage making it non-usable.

WARNING

Stepping over the tow bar may cause personnel to trip and fall. Do not step over tow bar once connected to aircraft and tow vehicle. Failure to observe this warning may result in injury to personnel.

- j. Connect tow bar to aircraft. (Applicable technical data.)
 - k. Connect tow bar to tow vehicle. Close the tow vehicle pintle hook and install locking pin.
 - l. Clean accumulated debris from exposed landing gear strut surfaces using aircraft operational strut fluid.
 - m. Position wing, tail, and chock walkers as needed.
- 7.3.2 Tow aircraft.

CAUTION

Landing gear struts will be damaged if an aircraft is towed on completely deflated struts. Do not tow aircraft on completely deflated struts (except disposal aircraft). Failure to observe this caution may result in damage to aircraft.

NOTE

Aircraft coded for disposal may be towed on completely deflated struts.

- a. If strut bottoms out during towing operations, stop towing and re-inflate struts to a minimum of 1-3 inches. (Applicable technical data.)

NOTE

Do not block tow or taxi lanes.

- b. If strut continues to deflate while aircraft is being towed, stop towing operations and repair or replace the strut. (Applicable technical data.)
- c. Park aircraft with main and nose gear tires placed on AM-2 matting, or other suitable material.
- d. Helicopters with skids shall be placed on wooden blocks placed on AM-2 matting per owning agency request.
- e. Chock aircraft wheels and secure forward and aft chocks to each other using attachment slats. See Figure 7-3 and Figure 7-4.
- f. Disconnect tow bar from tow vehicle.
- g. Disconnect tow bar from aircraft. (Applicable technical data.)
- h. Deflate landing gear struts to approximately 1-3 inches in height. (Applicable technical data.)

7.3.3 Local Manufacture of Desert Storage Chocks and Straps. Locally manufacture chocks and straps for desert storage aircraft as follows:

- a. Manufacture chocks from 6 x 6 inch of fir lumber or equivalent. For small frame aircraft, 4 x 4 inch of fir lumber or equivalent may be used.
- b. For 6 x 6 inch chock, bevel one edge the entire length of the chock at 45 degrees, 1.5 inch deep. For 4 x 4 inch, bevel one edge the entire length of the chock at 45 degrees, 1 inch deep.

c. Width of chock will vary depending on MDS and tire size.

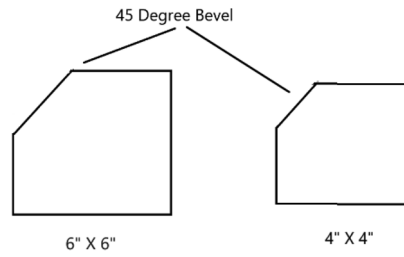

d. Wood slats used for securing the chocks to each other (forward & aft) are manufactured from 1 x 4 inch strips of fir lumber or equivalent cut to length as required.

e. Slats are secured to chocks with 8050 framing nail or equivalent (Figure 7-4).

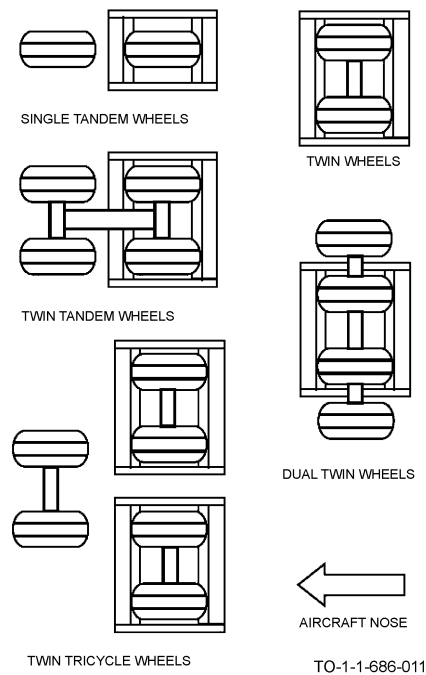
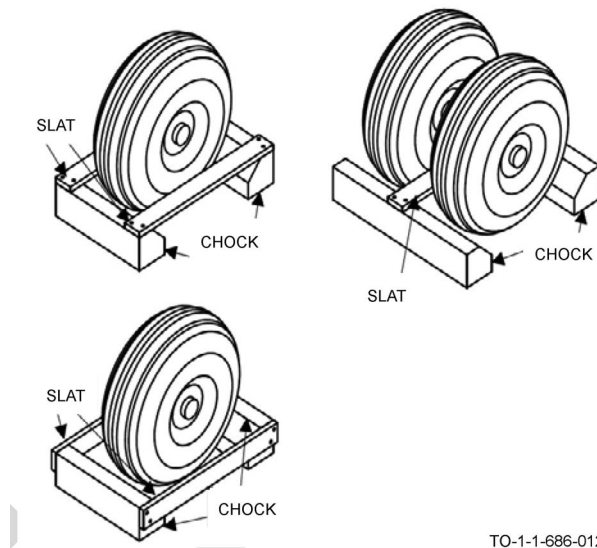

Figure 7-3. Chocking with Slats



TO-1-1-686-012

Figure 7-4. Chocks with Slats Attached

7.4 STORAGE AIRCRAFT TIRE INSPECTION AND SERVICING PROCEDURES.

7.4.1 AMARG Storage Aircraft Tire Inspection. Inspect tires per Table 7-2 and Figure 7-5. Tires that meet Table 7-2 criteria can be used for AMARG storage aircraft towing.

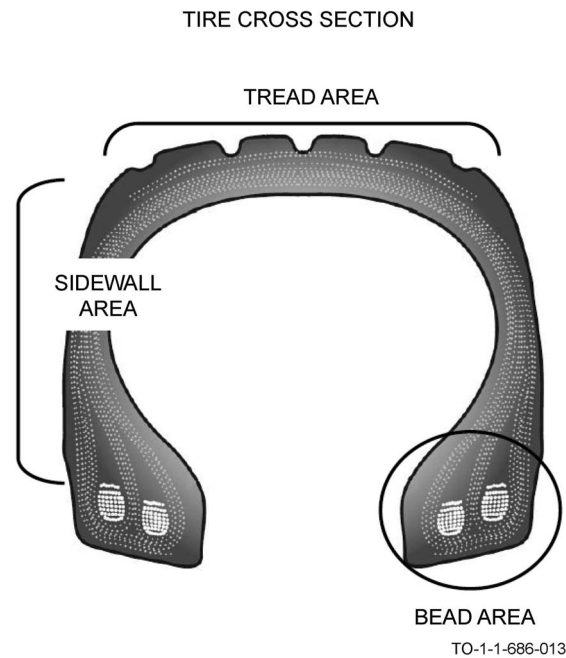

Figure 7-5. Tire Inspection Areas

7.4.2 Reseating Tire Bead.

- a. Remove wheel and tire assembly. (Applicable technical data.)
- b. Perform a visual inspection of tire bead area and remove any debris prior to servicing with nitrogen.

WARNING

Tires on storage aircraft may catastrophically fail due to deteriorated condition or over-pressurization. Tire failure may result in flying tire debris. Use required Personal Protective Equipment and avoid the tire inflation danger area during servicing. See Figure 7-6 for tire inflation danger areas. Failure to observe this warning may result in death or injury to personnel.

- c. Place wheel and tire in tire inflation safety cage. Reseat tire bead in accordance with TO 4T-1-3/NAVAIR 04-10-506 and the below steps.
 - (1) Additional test procedures from TO 4T-1-3/NAVAIR 04-10-506 are not required.
 - (2) Service tire to 40 percent of land base operating pressure.
 - (3) Apply leak check solution to tire bead area and check for leaks. A soap and water solution may be used as a leak check solution.
 - (4) Deplete tire pressure to 50 PSI and remove from inflation cage.
- d. Install wheel and tire assembly per Paragraph 1.10.
- e. Service wheel and tire on aircraft per Paragraph 7.4.4.

7.4.3 Servicing Uninstalled Tires. Perform tire servicing as follows for tires not installed on aircraft.

- a. Inspect tire per Paragraph 7.4.1.
- b. Perform a visual inspection of tire bead area and remove any debris prior to servicing with nitrogen.

WARNING

Tires on storage aircraft may catastrophically fail due to deteriorated condition or over-pressurization. Tire failure may result in flying tire debris. Use required Personal Protective Equipment and avoid the tire inflation danger area during servicing. See Figure 7-6 for tire inflation danger areas. Failure to observe this warning may result in death or injury to personnel.

- c. Place wheel and tire in tire inflation safety cage. Service tire in accordance with TO 4T-1-3/NAVAIR 04-10-506 and the below steps.
 - (1) Additional test procedures from TO 4T-1-3/NAVAIR 04-10-506 are not required.
 - (2) Service tire to 40 percent of land base operating pressure.
 - (3) Apply leak check solution to tire bead area and check for leaks. A soap and water solution may be used as a leak check solution.
 - (4) Deplete tire pressure to 50 PSI and remove from inflation cage.
- d. Install wheel and tire assembly per Paragraph 1.10.
- e. Service wheel and tire on aircraft per Paragraph 7.4.4.

7.4.4 Servicing Installed Tires. Service tires installed on aircraft as follows. Inflator kits Part Number (PN) 1075 or PN MA5352/1 or equivalent may be used to service tires.

- a. Perform partial lifting procedures per Chapter 1 until tire clears the ground.

WARNING

Tire or wheel may fail during inflation creating flying debris. Position servicing personnel forward or aft of the wheel and tire being serviced at the full length of the servicing hose. See Figure 7-6 for tire inflation danger areas. Failure to observe this warning may result in death or injury to personnel.

- b. Set low pressure tire inflator kit relief valve to 120 ± 30 PSI for low pressure tires.
- c. Set high pressure tire inflator kit relief valve to 420 ± 80 PSI for high pressure tires.



A-A-59503, NITROGEN

19

- d. Inflate tire with nitrogen, A-A-59503, to a minimum of 40 percent of the normal land base operating pressure from applicable technical data.
- e. De-pressurize jack until tire is on ground and remove jack.

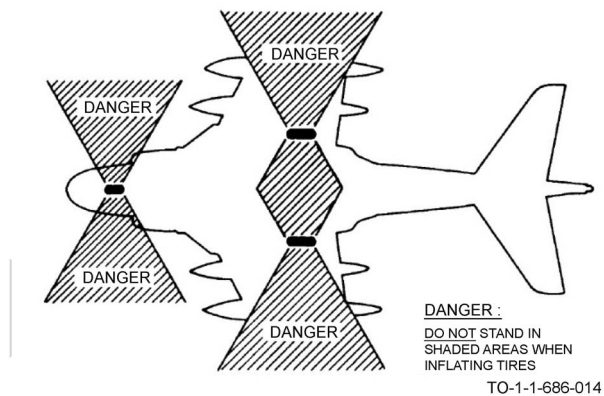

Figure 7-6. Tire Inflation Danger Areas

7.5 MOORING STORAGE AIRCRAFT.

AMARG storage aircraft are moored with wire rope attached to augers that are driven into the soil. Additional wire rope and augers may be positioned forward or aft of specified locations to provide additional mooring capability. Additional wire rope or augers should be placed to maintain tire clearance angles, centerline pull angles, and vertical pull angles per Figure 7-7 and Figure 7-8. Owning agency may provide additional mooring positions for specific aircraft models. Combinations of wire rope, chains, rope, or cargo straps may be used temporarily to secure aircraft.

7.5.1 Mooring Aircraft.

- a. Identify aircraft mooring point locations. (Applicable technical data.)
- b. Position augers to allow for proper angular alignment per Figure 7-7 and Figure 7-8. and drive augers into ground.

CAUTION

Damage to aircraft may occur if wire rope rubs on aircraft structure or components. Position wire rope to avoid contact with aircraft or cover wire rope with a rubber or nylon hose to prevent chafing. Failure to observe this caution may result in damage to aircraft.

- c. Attach commercial grade wire rope with a minimum breaking strength of 6,400 pounds to aircraft mooring points and ground augers per Figure 7-8. Install commercial grade wire rope hardware.
- d. Position wire rope away from structure and other components to prevent chafing.
- e. Cover wire rope with rubber or nylon tubing to prevent chafing on aircraft structure or components when wire rope cannot be repositioned.

NOTE

Wire rope hardware does not require any specific torque.

- f. Pull wire rope tight and tighten wire rope clamp hardware per Figure 7-8.

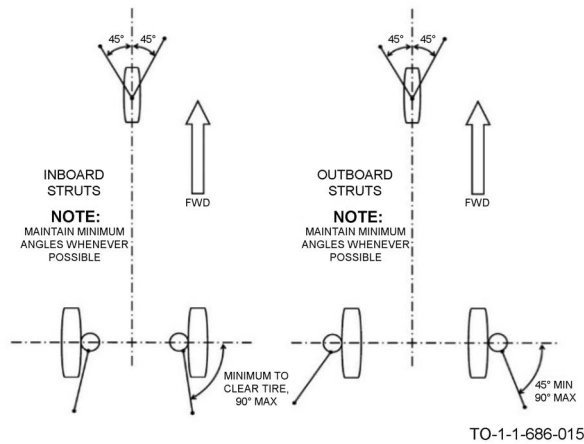

Figure 7-7. Cable Angular Relationship to Aircraft

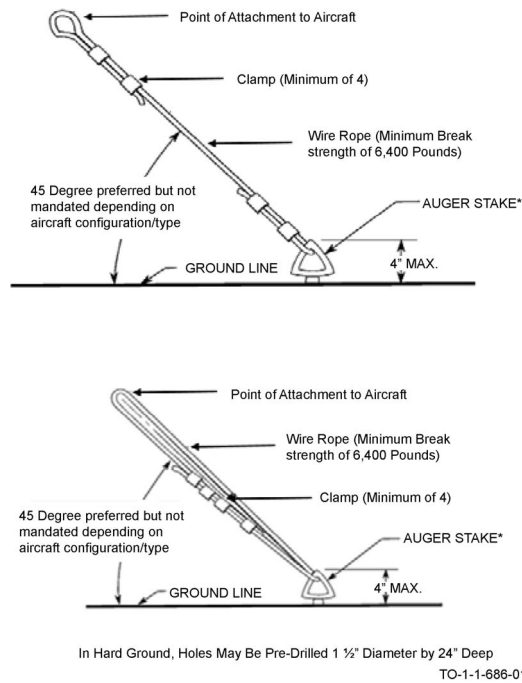

Figure 7-8. Cable Mooring Attachment

7.6 MOORING AIRCRAFT WITHOUT MOORING POINTS PRESENT.

If mooring points are not present due to parts or component removal, secure storage aircraft using main structural component locations suitable for mooring. Secure aircraft per Paragraph 7.5.1.

7.7 SECURING REMOVED AIRCRAFT COMPONENTS (NOT IN STORAGE CONTAINERS).

Aircraft components may be secured using wire rope, cargo strap or chains. The configuration of the component will determine suitable locations and methods for securing the component. Auger placement will depend on the component configuration. Cargo straps and chains rated at a minimum of 5,000 pounds can be used as a substitute for wire rope based on the configuration of the part being secured. Drive augers into the ground and secure the component to the augers.

Table 7-2. Storage Aircraft Tire Inspection

Inspection	Damage Limitation/Action
Contamination - Fuel, Hydraulic oil, oil or grease.	Visible contamination/Clean tire using water and soap, MIL-D-16791, to remove contaminants.
Sidewall Area: Weather checking/cracks/cuts	Maximum one layer of cord exposed/Replace wheel and tire assembly.
Sidewall Area: Bulges	No bulges allowed. Replace wheel and tire assembly.
Tread Area: Wear	Maximum of three layers of cord exposed or exceeds Maximum Wear Limit (MWL) identified on tire sidewall per TO 4T-1-3/Replace wheel and tire assembly.
Tread Area: Cuts	Cuts do not exceed cut limit on tire sidewall/Replace wheel and tire assembly.
Tread Chevron Cutting	Acceptable if all other criteria met.
Tread Rubber Separated	None acceptable/Replace wheel and tire assembly.
Tread Area: Bulges	No bulges allowed./Replace wheel and tire assembly.
Bead area	No visible bead wires allowed/Replace wheel and tire assembly.
Tire bead unseated from wheel	Acceptable if all other criteria are met/Reseat bead per Paragraph 7.4.2. and service wheel and tire per Paragraph 7.4.4.
Tire will not hold pressure (visibly flat after ten minutes)	Acceptable if all other criteria are met/Reservice and tow aircraft/If tire will not hold air/Replace wheel and tire assembly.
Tire partially deflated/bead seated	Acceptable if all other criteria met/Service wheel and tire per Paragraph Paragraph 7.4.4. Partial lifting not required. Inspect bottom of tire by towing aircraft to expose bottom of tire.
Tire completely deflated	Acceptable if all other criteria are met/Service wheel and tire per Paragraph 7.4.4.

CHAPTER 8

PREPARATION FOR FERRY FLIGHT

8.1 GENERAL.

This section contains instructions for preparation of aircraft for ferry flight. All aircraft other than Navy aircraft shall be prepared for ferry flight in accordance with applicable technical data and owning agency Statement of Work. Navy aircraft shall be prepared for ferry flight using this chapter. The Navy shall provide a Statement of Work identifying the specific requirements within this section to be performed for each aircraft and the applicable technical data to use for completing each requirement.

8.2 REQUIREMENTS.

8.2.1 Aircraft Preparation. Remove all sprayable strippable coatings, wash and lube aircraft per Chapter 2.

8.2.2 Lubrication. If aircraft has been in storage for 90 days or more, lubricate items exposed to exterior environment and any items exposed to cleaning compounds or other maintenance chemicals.

8.2.3 Interior Preparation. Remove all barrier materials, tape, and storage covers from aircraft interior.

8.2.4 Inspection. Inspect aircraft and components/systems as required to ensure aircraft is safe for flight in instrument meteorological conditions.

8.2.5 Required Operable Systems. Required operable systems are specified in CNAFINST 4790.2, OPNAVINST 3710.7, and the remainder of this section.

8.2.6 Loose and Emergency Equipment. Install all loose and emergency airborne equipment, such as slings, jacks, ladders, tools, hand-cranks, covers, and anchors and properly secure items in their designated place within aircraft.

8.2.7 Inventory aircraft. Install all removed items from aircraft, and items required for ferry flight. Including the following:

- Emergency rations.
- Exposure and pressure suits.
- Litters.
- Any other items received with aircraft.

8.2.8 Weight and Balance. Perform weight and balance calculations. (Applicable technical data.)

8.2.9 Safety of Flight Directives. Review all IMMEDIATE and URGENT category technical directives applicable to aircraft model, including those which were published after aircraft was first received at Aerospace Maintenance and Regeneration Group (AMARG) for storage. Comply with all IMMEDIATE category directives and all URGENT category directives affecting any item required for ferry flight with a compliance requirement within the next 10 flight hours/10 days.

8.2.10 Scheduled Maintenance Requirements.

- Subsequent to depreservation and prior to Functional Check Flight, comply with TURNAROUND/SERVICING/DAILY and Safety of Flight portion of SPECIAL/CONDITIONAL maintenance requirement cards applicable to aircraft model.

- Subsequent to Functional Check Flight, comply with TURN AROUND/SERVICING/DAILY, and SPECIAL/CONDITIONAL maintenance requirement cards applicable to aircraft model. The DAILY and TURNAROUND inspections shall be completed prior to flight in time intervals as specified in CNAFINST 4790.2.

8.3 AIRFRAME SYSTEMS.

8.3.1 Radomes. Inspect radomes. (Applicable technical data.) Check unpressurized radome drain holes to ensure that they are open and free of obstruction.

8.3.2 Access Doors. Inspect all doors for discrepancies which would affect safety of flight.

8.3.3 Bilges. Remove all accumulated debris, water, fuel, and hydraulic oil from bilges. Inspect bilges for corrosion, structural damage, or leaks which would affect safety of flight. Clean and air purge as necessary to remove all traces of fuel fumes.

8.3.4 Cables. Inspect all visible and accessible primary flight control, flight control surface locks, landing gear and engine control cables for corrosion and condition. (Applicable technical data.)

8.3.5 Canopies. Check all acrylic surfaces for damage, such as fogging, cracking, or crazing. Replace all acrylic surfaces that are unsafe for ferry flight.

8.3.6 Windshields. Check windshields to ensure they are not cracked, crazed, or discolored.

8.3.7 Cockpit Enclosures and Cabin Doors. Check cockpit enclosures and cabin doors to ensure they are operative and that emergency exit mechanisms are functional.

8.3.8 Pressurized Aircraft. Perform pressurization check. (Applicable technical data.)

8.3.9 Cockpits. Inspect cockpits for debris and discrepancies which would affect safety of flight. Replace missing nameplates, illegible markings, etc.

8.3.10 Escape Chutes and Doors. Functional check aircrew escape chutes and doors. (Applicable technical data.)

8.3.11 Fairings. Inspect all fairings for serviceability and proper adjustment. Correct discrepancies that affect safety of flight. (Applicable technical data.) Fairings and related attaching mechanisms which are not usable due to excessive wear, damage, distortion, etc., may be removed and stowed (secured) in aircraft if removal does not affect flight characteristics or cause carbon monoxide contamination.

8.3.12 Fuselage, Wings, and Empennage. Inspect wings, fuselage, control surfaces and empennage for discrepancies that would affect safety of flight. Inspection shall be as extensive as possible without disassembly, but shall be thorough enough to make sure all structural components, such as skin, stringers, frames, ribs, and hinge points, are safe for flight. Correct discrepancies. (Applicable technical data.)

8.3.13 Hull Aircraft. Install rivets in holes or reinstall drain plug in hull if previously opened for drainage. (Applicable technical data.)

8.3.14 Hinges. Check to make sure all hinges (including piano wire type) and flight control surface hinge points are lubricated, structurally sound, and function properly.

8.3.15 Composite Surfaces. Owning agency cognizant engineering authority shall assess non-reparable damage discrepancies and provide disposition.

8.4 MECHANICAL CONTROLS.

Operationally check power control or power boosted control systems on primary and alternate or secondary power source as applicable. (Applicable technical data.)

8.4.1 Helicopter Mechanical Controls. Ensure flight controls, control locks, and rotor brakes are in good operating condition and have specified amount of travel with boosters ON and OFF and power application is normal.

8.4.2 Wing Fold Mechanisms. When wing fold mechanisms are fully operative, use normal controls to make sure wings are spread and locked. Unless otherwise directed, it is not necessary to functionally check wing fold systems provided the wings were not folded while the aircraft was at AMARG and it can be definitely ascertained that no parts were removed or systems disturbed which would remain unknown unless the wings were folded. Placard instrument panel and inform the pilot that the wing fold system was not functionally checked. When wing fold mechanisms are inoperative, wings may be spread and locked in the fixed position as follows.

- a. Manually spread wings and position wing fold locking pins in the LOCKED position. (Applicable technical data.)
- b. Block off defective components. Cap or plug all hydraulic lines and openings, using machine threaded pressure-seal, metallic-type caps and plugs, and secure free ends of any disconnected lines. Refer to NAVAIR 01-1A-17.
- c. Apply normal operating hydraulic pressure to wing fold system. Make sure no leaks are present.
- d. Safety wire wing fold control in SPREAD position, and placard control handle with a notation: "Wing Fold Inoperative."
- e. Pull applicable circuit breakers and install clip to hold in no power position.
- f. Make the following logbook entry: "Wing fold system blocked off (state location). Components leaking and/or inoperative."

8.5 MOVEABLE SURFACES.

Operationally check control surfaces (including flaps and dive or speed brakes). Check for operating condition, specified travel, and normal power or pressure application for actuation. Operationally check normal and emergency operation.

8.5.1 Hydraulically Actuated Control Surfaces. Inspect hydraulically actuated control surfaces to make sure the actuators do not leak in excess of limits. (Applicable technical data.)

8.5.2 Composite Surfaces. Inspect composite movable control surfaces to ensure they are satisfactory for flight. Ensure drains are open and hinge points are in good condition. (Applicable technical data.)

8.5.3 Aircraft Flaps with Jackscrews and Tracks. Remove preservative grease the first time flaps are extended. Fully extend flaps and lubricate jackscrews and tracks. (Applicable technical data.)

8.6 SEATS (EXCEPT EJECTION SEATS).

Functionally check pilot and crew seats for security and operation. Install safety and survival equipment as required for ferry flight.

8.7 SURFACE CONTROL LOCKS.

Functionally check control surface and gust locks for normal operation.

8.8 TRIM TAB CONTROLS.

Functionally check trim tab controls and position indicators for normal operation.

8.9 ARMAMENT SYSTEMS.

Install armament equipment as necessary to attain weight and balance required for ferry flight. (Applicable technical data.) Depreserve only as necessary to install and secure in aircraft.

8.10 DRIVE AND GEARBOX SYSTEMS.

8.10.1 Aircraft/Engine Gearboxes. Drain and service aircraft/engine gearboxes with operating lubricating oil. Perform operational and leak check. (Applicable technical data.)

8.10.2 Helicopter Main Transmissions and Intermediate/Tail Rotor Gearboxes. Drain and service helicopter main transmissions and intermediate and tail rotor gearboxes with lubricating oil. Perform operational and leak check. (Applicable technical data.)

8.10.3 Transmission and Clutch Mechanisms. Perform operational check of transmission and clutch mechanisms.

8.10.4 Tail Rotor Shafts. Align tail rotor shafts, check end play and inspect tail rotors and gearboxes for cracks. (Applicable technical data.)

8.10.5 Rotor Heads. Inspect rotor heads for cracks and foreign matter. Repair as required.

8.11 ELECTRICAL/ELECTRONIC/FIRE CONTROL SYSTEMS.

a. Functionally check electronic or electrically operated equipment required for ferry flight including reverse current relays, voltage regulators, and generators/alternating current and related circuit breakers. Ensure all installed fire control components are properly secured for flight.

b. Install fully activated dehydrating units in systems. For systems equipped with vapor cycle units, perform reheat cycle operation during depreservation engine run-ups.

8.11.1 Antennas. Service antennas in accordance with applicable directives.

8.11.2 Batteries. Install fully charged wet and/or dry batteries as required for ferry flight.

8.11.3 Connectors. Ensure all electrical connectors required for ferry flight are installed and secured, and any disconnected connectors are properly capped or cover and seal connector using electrical insulation tape, A-A-59163, Type II. Secure loose connectors to adjacent structure/wiring harness to prevent short circuits or interference with other operating mechanisms.

8.11.4 Lights. Ensure cockpit, flight crew, running, and landing lights and systems warning/caution lights operate normally.

8.11.5 Pylon Fittings. Remove barrier materials and preservative compounds.

8.11.6 Starters and Generators. Inspect aircraft starters or generators for water contamination, cleaning fluids, dust or other foreign matter by removing access covers. Clean contaminated units in the installed position using compressed air to remove dust and loose dirt.

8.11.7 Emergency Generators. Functionally check emergency electrical generating systems for normal operation.

8.11.8 Multi-engine Installations. For multi-engine installations, parallel generators.

8.12 TRANSMITTING, RECEIVING, NAVIGATING, SEARCH AND RECOGNITION (IFF) EQUIPMENT.

Verify aircraft has operational two-way radio capability.

8.12.1 Intercom Equipment. Verify aircraft intercom equipment required for ferry flight is functional.

8.12.2 Directional Finding Equipment. Ensure a minimum of one operational directional finding unit is installed. TA-CAN is preferred but VOR may be used when installed. If neither is installed, then ADF or UHF DF must be operative.

8.12.2.1 If no other directional finding unit is installed, make sure low frequency range receiver is fully operative.

8.12.3 Compasses. Aircraft shall be equipped with a minimum of one fully operative, currently calibrated, remote reading compass and magnetic compass.

8.12.4 Identify Friend or Foe (IFF) or Selective Identification Feature (SIF) Equipment. Ensure installed IFF or SIF equipment is fully operative.

8.13 FUEL SYSTEMS.

8.13.1 Fuel System. Depreserve fuel system and engines per Chapter 6. To assist in restoring flexibility to fuel metering devices, diaphragms, seals, etc., depreserve fuel systems at least 8 hours prior to engine run-up.

8.13.2 Fuel Tank Foam Reinstallation. Fuel tank foam removed for storage may not be required to be reinstalled for ferry flight unless needed to support tanks, wiring, plumbing, etc. Functional testing of the fuel system is required. If aircraft is to be flown without reinstallation of foam, annotate aircraft logbook. Adjust weight and balance to account for missing foam. Perform fuel quantity calibration for tanks without foam.

8.13.3 Fuel Tank Foam in Aircraft Tanks During Storage. Perform one of the following procedures if aircraft had foam installed during storage.

- a. Procedure One. Remove, package and dispose of fuel tank foam. Functionally test fuel system. (Applicable technical data.)
- b. Procedure Two. Remove, inspect and reinstall fuel tank foam. Functionally test fuel system. (Applicable technical data.)



MIL-PRF-6081, LUBRICATING OIL, JET ENGINE

8

- c. Procedure Three. (For ferry flight to a rework facility only.) A minimum of three fills and drains of all fuel tanks shall be accomplished utilizing either operational clean filtered service fuel or filtered MIL-PRF-6081, Grade 1010 oil. At the end of each defuel cycle and prior to new refueling all fuel drains (sumps, filter drains, etc.) shall be drained and fuel filters inspected for contamination by deteriorated foam products.
 - (1) Two samples (utilizing containers furnished in MIL-K-23714, Aviation Fuels Sampling Kit or equivalent) shall be taken during the third filling from the refueler to obtain a baseline contaminant level. Samples shall be representative of the servicing fuel by sampling from the servicing hose after first discharging from the hose a volume of fuel estimated at two times the capacity of the piping system. These samples shall not be taken from refueler sump or filter separation drain.
 - (2) After completing the third filling of the aircraft fuel system a complete set of samples (all aircraft tanks) shall be taken at time of residual draining during completion of the third defueling. Samples shall be forwarded to an aerospace fuels laboratory in accordance with NAVAIR 00-80T-109. A solid contamination of 2 mg/liter over that serviced to the aircraft during filling will require removal and inspections of the foam as specified in Procedure One.

8.13.4 Cells. Verify fuel cell capacity is adequate for the longest contemplated flight plus reserve required by flight planning. Install external fuel tanks as necessary to meet fuel capacity requirements.

8.13.5 Unusable Fuel Cells. Unusable fuel cells not required for ferry flight may be blocked off. Block off fuel cells. (Applicable technical data.) Identify unusable cells by placarding fuel selector valve. Unusable fuel cells shall be identified at refueling points as follows:

- a. For fuel filler caps stencil adjacent to cap in 3/4-inch high red letters "Fuel Cell Blocked Off, Do Not Service."
- b. For single point refueling systems, placard refueling panel with white letters on a red background: "Fuel Cell Number ___ Blocked Off. Do Not Fuel."

c. Secure switches/circuit breakers as necessary to prevent fueling the unusable cell.

8.13.6 Emergency Fuel Systems. Ensure emergency fuel systems (including applicable cell jettisonable systems) function normally.

8.13.7 Strainers and Filters. Check fuel strainers, sumps, and drains. Clean and/or replace filters. (Applicable technical data.)

8.13.8 Filler Caps. Check filler caps for security. Verify required fuel grade is prominently displayed near filler cap.

8.13.8.1 Operationally check fuel systems required for ferry flight (including fuel booster and transfer pumps and fuel quantity indicating systems). (Applicable technical data.) Service aircraft fuel system.

8.14 HYDRAULIC SYSTEMS.

8.14.1 Partially Disassembled Systems. Reassemble systems as necessary for ferry flight. Service to normal operating levels. (Applicable technical data.)

8.14.2 Hydraulic Systems. Check aircraft processing records or logbooks for entries indicating that systems or subsystems were preserved without decontaminating. Decontaminate or replace affected components before flight. Comply with NAVAIR 01-1A-17.

8.14.3 Hydraulic System Contamination Check. Perform hydraulic system contamination check as follows.

a. Functionally check hydraulic systems. Cycle all elements of the hydraulic system a minimum of six times. Leak check system. (Applicable technical data.)

b. Take a hydraulic sample. Check for contamination. Reference NAVAIR 01-1A-17

c. If system is not contaminated, service systems to normal operating capacity. (Applicable technical data.)

d. If system is contaminated, repair system in accordance with NAVAIR 01-1A-17. (Applicable technical data.)

8.14.4 Actuator Piston Rods. Lubricate rods by wiping with a cloth saturated with applicable hydraulic fluid.

8.14.5 Emergency Systems. Inspect emergency hydraulic systems for security and integrity of components. Functionally check system. (Applicable technical data.)

8.14.6 Fluid Reservoirs. Ensure fluid specification is clearly marked near reservoir filler. Service to normal operating level with operational hydraulic fluid.

8.14.7 Pressure Accumulators. Service accumulators to normal operating pressures. (Applicable technical data.)

8.14.8 Boost Units. Check hydraulic flight control boost systems for normal function and leakage in excess of allowable limits. (Applicable technical data.)

8.14.9 Hydraulic Lines. Visually inspect coupling nuts on exposed hydraulic lines and coupling nuts identified in aircraft corrosion prone charts for stress corrosion cracking. Replace as necessary.

8.15 PNEUMATIC SYSTEMS.

8.15.1 Partially Disassembled Systems. Reassemble systems as necessary for ferry flight. (Applicable technical data.)

8.15.2 Pneumatic Lines. Visually inspect coupling nuts on exposed pneumatic lines and coupling nuts identified in aircraft corrosion prone charts for stress corrosion cracking. Replace as necessary.

8.15.3 Pneumatic Systems. Perform operational check and leak check. (Applicable technical data.)

8.15.4 Nitrogen/Air Bottles. Service nitrogen/air bottles. (Applicable technical data.)

8.15.5 Air Compressors. If required for ferry flight, service air compressor lubrication systems and operationally check. (Applicable technical data.)

8.15.6 Chemical Air Dryers. Service chemical air drier/ dehydrators. (Applicable technical data.)

8.16 INSTRUMENT SYSTEMS.

Instruments as required in CNAFINST 4790.2 shall be installed and operative. One complete set of required instruments shall be available to pilot's position for side by side seating.

8.16.1 Instrument Duplication. Duplication of pilot instruments for copilot position is not required.

8.16.2 Inoperative Instruments. Inoperative instruments not required will be placarded as inoperative. Use white lettering on red background to identify inoperative systems and instruments.

8.16.3 Air Filters. Clean and install new filters in instrument system as required. (Applicable technical data.)

8.16.4 Desiccant. Install new desiccant. (Applicable technical data.)

8.16.5 Automatic Pilot and Stabilization Units. If system is operational and required for ferry flight, operationally check automatic pilot and stabilization units. (Applicable technical data.)

8.16.6 Inoperative Automatic Pilot and Stabilization Units. Inoperative and other automatic pilot and stabilization units not required for ferry flight shall be processed as follows.

- a. Deactivate by installing a clip on circuit breakers to hold in a no power position, or otherwise disconnect the power source.
- b. Disconnect mechanical disconnects as required by applicable technical data.
- c. Placard aircraft cockpit with the following notation: "Auto pilot inoperative – deactivated."
- d. Make a logbook entry as follows: "Auto pilot inoperative. Deactivated by (state method and location)."

8.16.7 Instrument Panels. Clean instrument panels, functionally check all switches and knobs required for ferry flight. Ensure instrument lenses and illumination provisions are in good condition.

8.17 PITOT TUBES, ANGLE OF ATTACK AND STATIC VENTS.

Verify pitot tubes and static vents are clean and free of obstruction. Test pitot static system. (Applicable technical data.)

8.18 LANDING AND ARRESTING GEAR SYSTEMS.

Inspect all landing gear components. (Applicable technical data.)

8.18.1 Landing Gear Functional Check. Perform a landing gear functional check including emergency extension system. (Applicable technical data.)

8.18.2 Arresting Gear Hooks. Inspect and functionally check arresting gear system. (Applicable technical data.)

8.18.3 Arresting Gear Dashpot. Service dashpot. (Applicable technical data.)

8.18.4 Shock Struts.

- a. Clean and lubricate strut surface with strut operating fluid. Service struts. (Applicable technical data.)

- b. Inflate struts to normal operating height. (Applicable technical data.)
- c. Measure and record exposed length of struts.
- d. Inspect exposed length of struts after 48 hours, and compare with Table 8-1. Measure exposed strut dimension to nearest ¼ inch.
- e. If the exposed length is less than the minimum shown in Table 8-1, test and repair as required. (Applicable technical data.)

Table 8-1. Strut Leakage Limits

Original Exposed Strut Length (Inch)	Minimum Exposed Strut Length After 48 Hours (Inch)
1	3/4
2	1-3/4
3	2-1/2
4	3-1/2
5	4-1/4
6	5
7	6
8	6-3/4
9	7-3/4
10	8-1/2
11	9-1/2
12	10-1/4
13	11-1/4
14	12
15	13
16	13-3/4
17	14-1/2
18	15-1/4

8.18.5 Axles, Bearings, Brakes, and Wheels. Process as follows:

- a. Completely deflate tires and remove wheel and tire assembly from axle.
- b. Inspect axles for corrosion. Repair corrosion if found. (Applicable technical data.)



MIL-PRF-680, SOLVENT, DEGREASING, TYPE II AND III

2

- c. Clean brake assemblies using dry cleaning solvent, MIL-PRF-680, Type II. Do not disassemble brakes further than necessary for adequate cleaning. Check hydraulic brake system fluid for contamination or service as necessary. (Applicable technical data.)
- d. Install new wheel and tire assemblies. (Applicable technical data.)
- e. Functionally check braking systems. Check hydraulic brake system fluid for contamination or service as necessary. (Applicable technical data.)

8.18.6 Landing Gear, Gear Boxes. Service gearboxes. (Applicable technical data.)

8.18.7 Ground Steering Mechanisms. Functionally check ground steering mechanisms for proper steering, swiveling and locking functions.

8.18.8 Locks. Ensure landing gear and tail wheel locks function properly.

8.18.9 Shimmy Dampers. Service to normal operating level with appropriate operational fluid. (Applicable technical data.) Ensure shimmy dampers function properly. (Applicable technical data.)

8.18.10 Drag Chutes. Install serviceable, properly rigged drag chutes for aircraft so configured.

8.19 PHOTOGRAPHIC SYSTEMS.

a. Secure installed photographic equipment for flight. If photographic equipment is not installed, install ballast as necessary to maintain weight and balance.

b. Clean photographic equipment required for ferry flight. (Applicable technical data.)

c. Service photographic dehydration units required for ferry flight. (Applicable technical data.)

8.20 POWER PLANT SYSTEMS.

a. Depreserve engines per Chapter 6 and NAVAIR 15-01-500.

b. Engine pre-oiling. Pre-oil gas turbine engines if required. (Applicable technical data.)

8.20.1 Mounts. Inspect engine mounts. (Applicable technical data.)

8.20.1.1 Perform engine borescope inspection directed by owning agency or applicable technical data.

8.20.2 Tail Pipes. Inspect tail pipes for cracks, overheating, distortion, and security.

8.20.3 Oil Filters and Magnetic Plugs. Inspect oil filters and magnetic plugs for condition and foreign matter. (Applicable technical data.)

8.20.4 Tubing, Hoses, Leads, and Clamps. Inspect engine tubing, hoses, leads, and clamps and ensure that they are secure and show no evidence of leaking, crimping, or chafing.

8.20.5 Engine Nacelle/Cowling. Ensure engine nacelle cowling is complete and secure.

8.20.6 Cooling Tubes and Ducts. Ensure all cooling tubes and ducts are secure, clean, and free of obstruction.

8.20.7 Oil Tanks. Service oil tanks. (Applicable technical data.) Take oil samples. Report sample results to owning agency.

8.20.8 Ground Checks. Perform engine ground checks. (Applicable technical data.) Correct any malfunctions.

8.20.9 Leak Checks. Leak check engine fuel, oil, or hydraulic fluid lines. (Applicable technical data.)

8.20.10 Engine Accessories. Visually inspect engine accessories for security and leakage during engine ground checks.

8.20.11 Auxiliary Power Units. If required for ferry flight, service and operationally check auxiliary power units. (Applicable technical data.)

8.20.12 Propeller Anti-Ice Systems. Operationally check propeller anti-ice systems. (Applicable technical data.)

8.20.13 Propellers (Turbo-Prop Engines). For turbo-prop engines, the propellers shall operate normally throughout the entire power range including feather and reverse. Service the turboprop pitch change system with the appropriate operational fluid. (Applicable technical data.)

8.20.14 Propeller Governors. Functionally check propeller governors. (Applicable technical data.)

8.21 ROTOR AND HUB SYSTEMS.

8.21.1 Helicopter Rotor Blades and Tail Rotor. Inspect blades for serviceability. Install rotor blades and tail rotor blades. Inspect blade and control attachments. Balance blades and track blades if required. Inspect rotor blades for safe condition prior to engine operation. (Applicable technical data.)

8.21.2 Rotor Hubs. Inspect rotor hubs, controls and linkage for serviceability. (Applicable technical data.)

8.21.2.1 Lock any blade folding mechanisms in the operating position.

8.22 SAFETY AND SURVIVAL SYSTEMS.

8.22.1 Canopies. Clean and inspect canopy, canopy seals and canopy removal systems. (Applicable technical data.)

8.22.2 Ejection Seats.



DETONATION TRANSFER ASSEMBLY (DTA)/SHIELDED MILD DETONATION CORD (SMDC)

6

Inspect cartridge actuated escape systems and integral parachutes. Replace components as required for age or functional check failures. Tandem seat aircraft need not have the rear seat serviced provided it is not specifically required for flight by the ferrying activity (or is required for safe ejection of the forward seat). Mark the deactivated seat headrest with minimum of one-inch high letters, "Ejection seat is not serviced, do not occupy during flight." Securely stow seat belts, shoulder harnesses, communication cords, etc., on deactivated rear seats to prevent control entanglement. (Applicable technical data.)

8.22.3 Fire Extinguishers, Portable. Install charged portable fire extinguishers in all required locations.

8.22.4 First Aid Kits. Install first aid kits in all required locations for flight crew members.

8.22.5 Life Jackets and Life Rafts. For aircraft involved in over water flights, install fully operative "With-in Age" life jackets and life rafts as required for flight crew members.

8.22.6 Emergency Water Landing Survival Equipment. For aircraft involved in over water flights, when so configured, install emergency water landing survival equipment. For amphibious aircraft, ensure the installation of mooring and anchoring facilities (including sea anchors).

8.22.7 Personnel Parachutes. As required for ferry flight, install serviceable parachutes for all aircrew members.

8.22.8 Drag Parachutes and Harness. For those aircraft so equipped, install serviceable fully operative parachute assemblies.

8.22.9 Seat Belts, Shoulder Harness, and Inertia Reels (Including Ejection Seats). Inspect safety belts, shoulder harnesses, and inertia reels in accordance with NAVAIR 13-1-6.5, including life limits. (Applicable technical data.)

8.22.10 Oxygen Equipment. Purge and service oxygen system (including air crew emergency systems). (Applicable technical data.)

8.23 UTILITY SYSTEMS.

8.23.1 Air-conditioning Systems. Service air-conditioning turbines, compressors, and condenser units. Clean external air vents, ducts, and heat exchangers to remove accumulated soils. (Applicable technical data.)

8.23.1.1 Air conditioning and air distribution controls must function either automatically or manually. (Applicable technical data.)

8.23.2 Cabin Air Filters and Ducts. Remove and clean or replace cabin air filters. Vacuum clean filter holders and associated ducts to remove accumulated soils. Install and secure clean filters. (Applicable technical data.)

8.23.3 Anti-Icers. If required by CNAFINST 4790.2, service Anti-icer systems and perform operational checks. (Applicable technical data.)

8.23.4 Deicer Boots. If required for ferry flight, inspect and process deicer boots as follows:

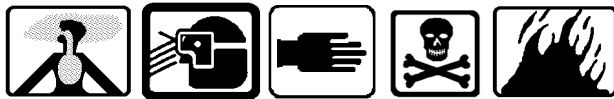

TT-I-735, ISOPROPYL ALCOHOL

15

a. Clean deicer surfaces. (Applicable technical data.) Rinse thoroughly, air dry, and wipe down with cloth saturated with isopropyl alcohol, TT-I-735.

b. Inspect deicer boots for damage and deterioration and repair if required. (Applicable technical data.)

8.23.5 Cabin Air and Pressure Suit Regulators. Inspect and operationally check cabin air and pressure suit regulators required for ferry flight. Clean or replace air filters. (Applicable technical data.)

8.23.6 Cabin Heaters. Inspect heater installation to ensure proper security for flight. Operationally check heater if required for ferry flight. (Applicable technical data.) For heater deactivating instructions refer to the NAVAL SUPPLY SYSTEMS COMMAND WEAPON SYSTEMS SUPPORT DET FIELD SUPPORT OFFICE.

8.23.7 Engine Fire Extinguisher Components. Service system as required. Operationally check engine fire extinguisher systems. (Applicable technical data.)

8.23.8 CAD Actuated Fire Extinguishers. Process CAD actuated fire extinguishers as follows:

a. Check extinguisher for correct pressure. Replace as necessary. (Applicable technical data.)

b. Check actuator cartridges expiration date. Install new cartridges as necessary, and place new metal date tags on affected containers. (Applicable technical data.)

8.23.9 Lavatory and Toilet Facilities. If ferry flight duration will be such that these facilities are required enroute, service and provision all units. (Applicable technical data.)

8.23.10 Windshield Defrosters. If required for ferry flight, operationally check and service windshield defrosters. (Applicable technical data.)

8.23.11 Windshield Wiper Blades and Arms. Unwrap, inspect windshield wiper blades and arms, replace if required. Remove preservative from exposed shafts. Install windshield wiper blades and arms. (Applicable technical data.)

8.23.11.1 Inspect windshield wiper blades and arms and replace if required. (Applicable technical data.)

8.24 FLIGHT TEST.

Conduct a flight test or local check flight and certify systems required for ferry flight in accordance with latest issue of OPNAVINST 3710.7 within 10 days of anticipated transfer date. Service aircraft fuel and oil systems to normal operating capacity following test or check flight.

8.25 LOGBOOK ENTRIES.

Make appropriate entries, transfer all applicable data from local worksheets to logbooks in accordance with CNAFINST 4790.2. In addition make the following entry in inspection section of logbook under "Conditional Inspections" when requirements of this section have been completed. "Aircraft prepared for ferry flight in accordance with CNAFINST 4790.2 and NAVAIR 15-01-4."

CHAPTER 9

GENERAL DISPOSAL PREPARATION PROCEDURES

9.1 GENERAL INSTRUCTIONS.

This chapter contains disposal and demilitarization preparation procedures for storage aircraft and components that have completed final General Services Administration (GSA) screening. Disposal preparation generally consists of the removal of materials with special disposal requirements from aircraft and components prior to demilitarization. Disposal preparation also consists of the depletion of pressurized containers. Additional disposal preparation guidance can be found in Department of Defense (DoD) Demilitarization Manuals or provided by the responsible owning agency. Disposal preparation is conducted per Department of Defense, owning agency, and federal, state and local environmental requirements.

9.1.1 Aircraft and Component Disposal. Aircraft and component disposal preparation procedures are not "aircraft maintenance tasks". They are tasks being performed on DOD property to accomplish safe and environmentally acceptable material removal. Tasks that require compliance with applicable technical data for safety have (Applicable Technical Data) noted in the task description. The list of materials that are removed for disposal preparation is not a sequence of operations and do not have to be performed in order.

9.1.1.1 Alternate methods and equipment may be used to perform disposal preparation procedures as long as the task can be safely performed and no damage to equipment occurs. AMARG Engineering may provide guidance on any aircraft and component in disposal status to ensure disposal preparation procedures are accomplished in a safe manner. Process Orders, Risk Management and Job Safety Analysis may be used.

- a. Aircraft structure or components may be cut for material removal or fluid draining.
- b. Place removed panels and miscellaneous parts in aircraft or pre-disposal container or secure panels to aircraft.
- c. Mark aircraft per Paragraph 1.6. prior to starting disposal preparation operations.
- d. Mark aircraft per Paragraph 1.6. after all disposal preparation operations are complete.

9.2 ELECTRICAL AND AVIONIC MATERIAL REMOVAL.



ASBESTOS

20



MERCURY

21



RADIOACTIVE COMPONENTS

22

Remove all electrical and avionics system components containing known or suspected materials with special disposal requirements. Examples may include, but are not limited to, polychlorinated biphenyl (PCB) components, radioactive material, mercury, lead, asbestos, beryllium and boron. Wire bundles, air lines and other component inputs may be disconnected or cut to facilitate component removal. Disconnected electrical connectors do not need to be covered.

9.3 ACCUMULATOR PRESSURE DEPLETION.

Deplete aircraft pressurized accumulators containing nitrogen or air. Vent and leave accumulator open to atmosphere.

NOTE

Only trained and certified personnel will recover refrigerant. Review the AMARG specific Safety Summary for additional information.

9.4 REFRIGERANT RECOVERY.



LIQUID REFRIGERANT

9

Recover refrigerant from evaporator and condenser units. (Applicable technical data.)

9.5 FLUID REMOVAL.

- a. Drain aircraft systems or components including fluid lines, fluid reservoirs, fluid accumulators, fluid tanks, fuel cells, external fuel tanks, fluid heat exchangers, actuators, engine oil tanks, gearboxes, constant speed drives, generators, fuel controls, fuel coolers, oil coolers, hydraulic components, and fuel filters of fuels, oils and hydraulic fluids.
- b. Identify accessible components and fluid system low points for fluid draining.
- c. Open applicable panels.
- d. Drain fluids by any of the following methods:
 - (1) Method 1. Open component drain valves or remove drain plugs.
 - (2) Method 2. Disconnect fluid lines at system or component low points or lowest accessible points and drain fluid.
 - (3) Method 3. Mechanically siphon fluid from accessible reservoir, tank, or storage component.
 - (4) Method 4. Cut fluid lines for draining.
- e. Close component drains and connect, cap or plug opened fluid lines after draining. Crimp cut fluid lines to prevent residual leakage.
- f. Remove fuel foam from integral fuel cells.
- g. Vent aircraft fuel cells and external fuel tanks to atmosphere after draining.
- h. Perform Lower Explosive Limit (LEL) check on aircraft fuel cells and external fuel tanks. Per TO 1-1-3, fuel cells and fuel tanks must be below Hot Work LEL limits.
- i. Mark the letters "LEL" followed by the LEL measurement completion date on the aircraft or external fuel tank per Chapter 1.

9.6 OXYGEN SYSTEM DEPLETION.

- a. Vent Liquid Oxygen (LOX), Gaseous Oxygen (GOX) and Portable Oxygen (POX) bottles to atmosphere.
- b. Remove portable chemical oxygen generators. Do not activate chemical oxygen generators. Contact AMARG engineering or Bioenvironmental Engineering for disposal disposition.

- c. Check oxygen system or container pressure gauges.
 - (1) If oxygen system or oxygen container pressure gauges do not indicate zero, deplete system or container. Consult applicable technical data, AMARG Process Orders or contact AMARG Engineering for depletion procedures.
 - (2) If oxygen system or oxygen container pressure gauges indicate zero, the system is depleted.
- d. Open oxygen system lines to vent system to atmosphere.
- e. Leave oxygen system lines open to atmosphere.

9.7 EMERGENCY SLIDE SYSTEM PRESSURE DEPLETION.

Deplete pressurized emergency slide system containers containing nitrogen or air. Vent and leave open to atmosphere. Consult applicable technical data, AMARG Process Orders or contact AMARG Engineering for depletion procedures.

9.8 HALON CONTAINER REMOVAL.

Halon containers will be removed from aircraft. Halon is an ozone depleting substance. Review the AMARG specific Safety Summary for additional information.



HALON FIRE EXTINGUISHER CYLINDERS

23

- a. Verify cylinder explosives (squibs) are removed.
- b. Remove all Halon cylinders from aircraft.

9.9 MERCURY COMPONENT REMOVAL.



MERCURY

21

Remove all known or suspected components or items containing mercury from aircraft (e.g. fluorescent light bulbs, gyroscopes, mercury switches, cathode ray tubes (CRTs) and thermometers).

9.10 ASBESTOS ABATEMENT.



ASBESTOS

20

Abate all known components or items containing asbestos from aircraft. Take samples of suspected asbestos material and send for analysis to determine composition. If material is confirmed to be asbestos, abate the material. Review the AMARG specific Safety Summary for additional information.

9.11 RADIOACTIVE MATERIAL REMOVAL.



RADIOACTIVE COMPONENTS

22

Remove all known radioactive components or items from aircraft. Evaluate suspected radioactive material to determine if it is radioactive. If material is confirmed to be radioactive, remove the material. Review the AMARG specific Safety Summary for additional information.

9.12 LANDING GEAR STRUT AND WHEEL ASSEMBLY PRESSURE DEPLETION.

Deplete the pressure from landing gear struts and wheel and tire assemblies.

- a. Deplete landing gear strut pressure per Chapter 1.
- b. If tire is deflated due to a broken tire bead, no further action is required.
- c. If tire is pressurized, remove the valve core and deflate wheel and tire assembly. Do not reinstall the valve core.

9.13 ENGINES.

Remove all known special disposal requirement materials listed in this chapter from engines. If the materials can be removed with the engine installed, the engine may remain on aircraft. If the engine requires removal for material removal, the installation of intake and exhaust covers are not required. Installation of electrical connector covers are not required. Cap any open lines to prevent fluid leakage.

9.14 CLASSIFIED INSPECTION.

Verify all known classified items have been removed from the aircraft. Notify owning agency if classified items are still installed on aircraft. If any classified items are still installed on the aircraft, remove the installed classified items.

9.15 EXPLOSIVE MATERIAL VERIFICATION.



EXPLOSIVE COMPONENTS

24

- a. Inspect asset for remaining installed explosives. (Applicable Technical Data.)
- b. Remove remaining installed explosives from aircraft. (Applicable Technical Data.)
- c. Verify all explosive items have been removed.

CHAPTER 10

GENERAL LIFTING PROCEDURES

10.1 GENERAL INSTRUCTIONS.

This chapter contains general guidance for lifting operations for aircraft and components in non-standard condition. The material contained herein is general in nature so it may be adapted to meet local operating requirements. However, nothing stated in this chapter shall be construed as a substitute for common sense or sound judgment. Lifting procedures are flexible in nature and may be modified as the circumstances dictate. These methods and procedures may be used to supplement existing technical data, when the other technical data is incomplete or when the methods and procedures specified are insufficient due to the circumstances. AMARG may use aircraft lifting equipment and procedures in TO 00-80C-1.

10.2 GENERAL EQUIPMENT.

10.2.1 Slings. Any combination of aircraft specific slings, hybrid round slings, synthetic slings etc. may be used for lifting operations. Determine the appropriate sling for the type, size and weight of the load being lifted. Additional information on slings can be found in ASME B30.9.

10.2.2 Rigging Hardware. Any combination of spreader bars, clevises, shackles, master links etc. may be used during lifting operations. Determine the appropriate rigging hardware for the type, size and weight of the load being lifted. Additional information on Rigging Hardware can be found in ASME B30.26.

10.3 MOTORIZED EQUIPMENT.

Single or multiple mobile cranes, forklifts or telehandlers, may be used during lifting operations.

- a. Ensure the load being lifted is within the load range of the crane, forklifts or telehandlers.
- b. Forklifts and telehandlers may be used for roll stabilization during lifting operations.

10.4 FIXED OVERHEAD CRANES.

Fixed overhead or trolley cranes may be used for lifting. Ensure the load being lifted is within the load range of the crane.

10.5 LIFTING OPERATIONS.

WARNING

- Precautions shall be taken to avoid fall and trip hazards during lift equipment connection and rigging. Failure to observe this warning may result in serious injury or death to personnel.
- Ensure all slings, sling configurations, and rigging hardware are capable of carrying the effective load and are used properly. Failure to do so could result in serious injury or death to personnel or damage to the aircraft.
- All personnel working or walking under cranes, slings, or other overhead objects shall wear hard hats. Failure to observe this warning may result in serious injury or death to personnel.

CAUTION

- During lifting operations, exercise care to minimize jerking motions or sudden start or stops. Excessive deflection stresses may cause damage to the aircraft or lifting equipment.
- Due to asset condition, the center of gravity may be unknown until the asset is actually lifted. Use of additional cranes and lifting and rigging equipment may be used to compensate for weight and balance conditions allowing loads to be lifted in a level position. Failure to comply could result in damage to, or destruction of, equipment or loss of mission effectiveness.

NOTE

If the aircraft structure at the lift station is damaged or a lack of structural integrity exists, consult AMARG engineering.

- a. Evaluate asset for potential imbalance and safety concerns prior to lifting operations.
- b. Accomplish Risk Management and Job Safety Analysis (JSA) as required.
- c. Contact AMARG Job Control as warranted for weather conditions prior to operations.

NOTE





- Single crane operations will not be performed if winds exceed 14 knots.
 - Task Supervisor will determine if multi-crane single lift operations can be performed for winds above 14 knots.
- d. Position equipment for lift.
 - e. Establish restricted area by placing cones around the load to be lifted, as warranted.

NOTE

Only lift team members and other personnel as authorized by lift team supervisor are permitted in the restricted area.

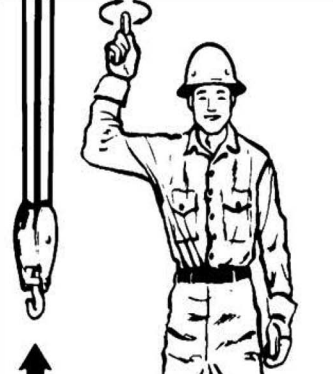



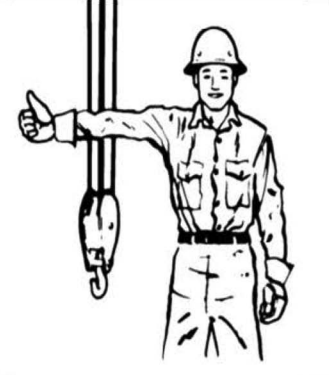
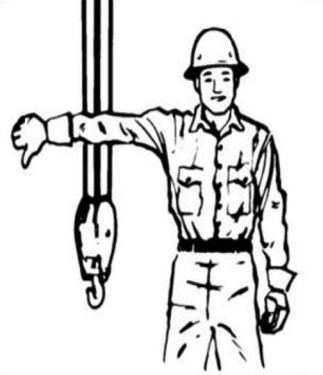
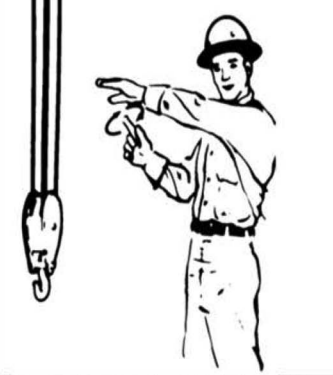
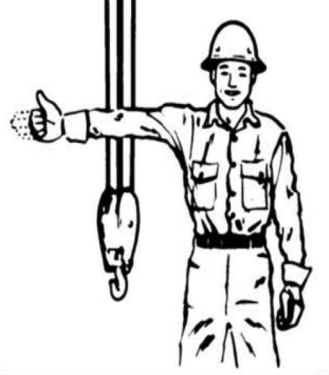
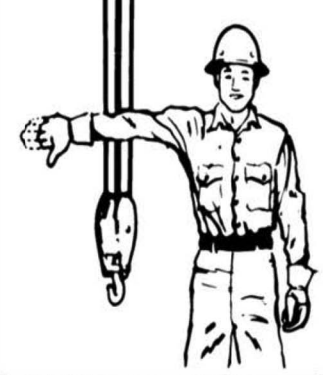

- f. Task Supervisor will Conduct Pre-Lift Safety Briefing.
 - (1) Task Supervisor will identify themselves, wear a reflective vest, and will direct the lift operation.
 - (2) The following topics may be briefed.
 - Personal Protective Equipment (PPE) requirements.

- Visual communication. (See Figure 10-1).
 - Voice communication (e.g. Two-way radio communication or wireless headsets).
 - Procedures for personnel under suspended loads.
 - Assigned areas of responsibility.
 - Egress routes.
 - “Knock It Off” procedures.
 - Asset lift sequence.
- g. Perform lift operation.
- h. Secure asset.

		
<p>HOIST. With forearm vertical, forefinger pointing up, move hand in small horizontal circle.</p>	<p>LOWER. With arm extended downward, forefinger pointing down, move hand in small horizontal circle</p>	<p>USE MAIN HOIST. Tap fist on head; then use regular signals.</p>
		
<p>USE WHIPLINE (Auxiliary Hoist). Tap Elbow with one hand; then use regular signals.</p>	<p>RAISE BOOM. Arm extended, fingers closed, thumb pointing upward.</p>	<p>LOWER BOOM. Arm extended, fingers closed, thumb pointing downward.</p>
		
<p>Move slowly. Use One hand to give any motion signal and place other hand motionless in front of hand giving the motion signal. (Hoist slowly shown as example.)</p>	<p>RAISE THE BOOM AND LOWER THE LOAD. With arm extended, thumb pointing up; flex fingers in and out as long as load movement is desired.</p>	<p>LOWER THE BOOM AND RAISE THE LOAD. With arm extended, thumb pointing down; flex fingers in and out as long as load movement is desired.</p>

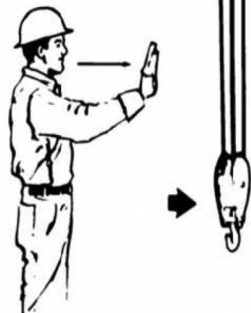
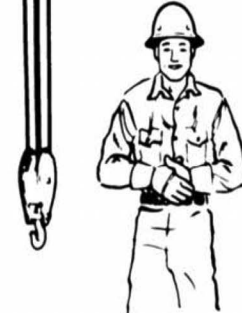
TO-1-1-686-017

Figure 10-1. Hand Signals for Crane Operation (Sheet 1 of 3)

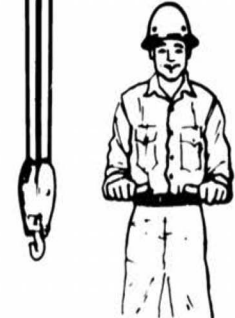
		
<p>SWING. Arm Extended, point with finger in direction of swing of boom.</p>	<p>STOP. Arm Extended, palm down, move arm back and forth horizontally.</p>	<p>EMERGENCY STOP. Both arms extended, palms down, move arms back and forth horizontally.</p>
		
<p>TRAVEL. Arm extended forward, hand open and slightly raised, make pushing motion in direction of travel.</p>	<p>DOG EVERYTHING. Clasp hands in front of body.</p>	<p>TRAVEL (Both Tracks). Use both fists in front of body, making a circular motion about each other, indicating direction of travel, forward or backward.</p>
		
<p>TRAVEL. (One Track). Lock the track on side indicating by raised fist. Travel opposite track in direction indicated by circular motion of other fist, rotated vertically in front of body.</p>	<p>EXTEND BOOM (Telescoping Booms). Both fists in front of body with thumbs pointing outward.</p>	<p>RETRACT BOOM (Telescoping Booms). Both fists in front of body with thumbs pointing toward each other.</p>

TO-1-1-686-018

Figure 10-1. Hand Signals for Crane Operation (Sheet 2)

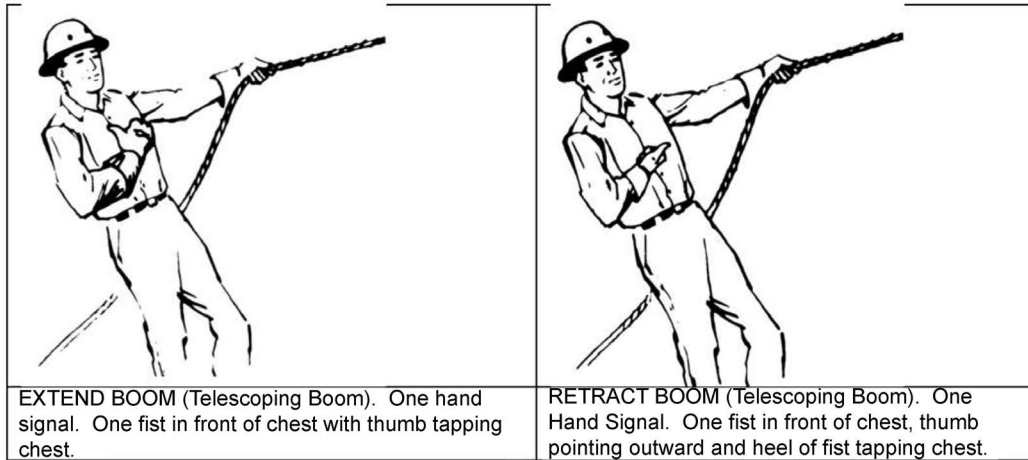

TO-1-1-686-019

Figure 10-1. Hand Signals for Crane Operation (Sheet 3)

CHAPTER 11 TOOLING STORAGE

11.1 TOOLING STORAGE.

Chapter 11 is reserved for tooling storage procedures at AMARG.

APPENDIX A

INSPECTION REQUIREMENTS CHECKLIST

A.1 AIRCRAFT STORAGE INSPECTION.

When possible AMARG will use current Air Force or Navy Basic Post Flight inspections for civilian, commercial and Department of Defense type aircraft that are similar in mission, design and series. When similar Air Force or Navy inspections do not exist, use the below inspection guidance as the equivalent Basic Postflight type inspection. The inspection guidance is general in nature and depending on the type of aircraft, all items may not apply. Annotate discrepancies on the proper aircraft form. Follow guidance per Chapter 2 for aircraft without maintenance forms.

Table A-1. Preparation

Number	Complete	N/A	Preparation Item
1			Perform aircraft forms review for completeness if available.
2			Position wheel chocks forward and aft of main landing gear wheels.
3			Statically ground aircraft.
4			Position portable fire extinguisher.
5			Install protective covers (as required).
6			Install Alternate Mission Equipment.
7			Safe Ejection Seat(s).
8			Install ground safety pins and locks.

Table A-2. Fuselage Inspection

Number	Complete	N/A	Inspection Items
1			Perform visual walk around check of aircraft fuselage and inspect for damage and fluid leaks. Report missing items per AFI 21-101 to the Quality Assurance Drop Object Manager.
2			Perform visual walk around check of aircraft empennage and inspect for damage and fluid leaks. Report missing items per AFI 21-101 to the Quality Assurance Drop Object Manager.
3			Perform visual walk around check of aircraft engine cowling and inspect for damage and fluid leaks. Report missing items per AFI 21-101 to the Quality Assurance Drop Object Manager.
4			Left and Right wing lower and upper surface for damage and fluid leakage. Inspect all access doors and covers for security. Report missing items per AFI 21-101 to the Quality Assurance Drop Object Manager.
5			Left and Right wing leading edge flaps for damage and security
6			Left and Right wing trailing edge flaps for damage and security.
7			Left and Right wing flap well structure, hydraulic lines, cables, electrical wiring and components for damage, cracks, broken wires and fluid leaks.
8			Upper and lower antenna(s) for cracks, dents, deterioration and security.
9			Nose landing gear door(s) and actuators for damage, security and fluid leaks.
10			Nose landing gear wheel well structure, hydraulic lines, electrical wiring, cables and components for damage, broken wires and leakage.
11			Radomes for damage, dents and deterioration.
12			Left and Right main landing gear doors and actuators for damage, security and fluid leaks.
13			Left and Right main landing gear wheel well structure, hydraulic lines, electrical wiring, cables and components for damage, broken wires and leakage.

Table A-2. Fuselage Inspection - Continued

Number	Complete	N/A	Inspection Items
14			Liquid or gaseous oxygen containers and attaching lines for leaks and security.
15			Navigation and position lights for damage and security.
16			Aircraft batteries for proper installation. Inspect battery cable for damage, proper installation, corrosion and broken connectors.
17			Battery compartment for damage and corrosion.
18			Attached external fuel tank(s) for damage, leakage, security, and filler caps installed.
19			Angle of Attack probes for damage and obstructions
20			Pitot tubes for damage and obstructions
21			Static ports for obstructions

Table A-3. Crew Station

Number	Complete	N/A	Inspection Items
1			Crew Station for foreign objects, cleanliness, security of components and general condition.
2			Seats, guide rails, safety belts for condition, corrosion and apparent defects.
3			Instrument panel gauges for damage, cracks, security, markings and lose or missing parts. Inspect switches, and attaching fasteners for security and missing parts.
4			Windows or canopies transparent material for cracks, scratches, and deterioration.
5			Crew entry door and door frame for damage, security and proper operation.
6			Canopy frame for damage and canopy seal for cuts, tears and deterioration. Check canopy for proper operation.
7			Interior sidewall panels and headliner for condition and security.
8			Circuit Breaker Panels for security and damage.
9			Visible electrical connectors and wiring for heat damage, corrosion, broken wires and security.
10			Installed oxygen system regulators for damage and security. Check oxygen hoses for cuts and deterioration.
11			Structures and components in accessible interior lower or aft crawl spaces for obvious leakage, damage and corrosion.
12			Visible control cables for kinks, fraying, and broken wires,

Table A-4. Cargo/Passenger Compartment

Number	Complete	N/A	Inspection Items
1			Window(s) transparent material for cracks, scratches, and deterioration.
2			Visible electrical connectors and wiring for heat damage, corrosion, broken wires and security.
3			Baggage compartment for wear, tears, and security.
4			Installed oxygen system regulators for damage and security. Check oxygen hoses for cuts and deterioration.
5			Structures and components in accessible lower or aft crawl spaces for obvious leakage, damage and corrosion.
6			Cargo and passenger area seats, galleys, and latrines for damage, leaks, corrosion and missing hardware.

Table A-4. Cargo/Passenger Compartment - Continued

Number	Complete	N/A	Inspection Items
7			Visible control cables for kinks, fraying, and broken wires,

Table A-5. Landing Gear

Number	Complete	N/A	Inspection Items
1			Nose landing gear shock strut assembly for security leakage and damage.
2			Nose landing gear steering components and cables for security damage, leakage and broken wires.
3			Nose landing gear wheel(s) for damage.
4			Nose landing gear tires for wear, cuts and proper inflation.
5			Nose landing gear hydraulic components and lines for security and leakage.
6			Left and Right main landing gear shock strut assemblies for security, leakage and damage.
7			Left and Right main landing gear wheel(s) for damage.
8			Left and Right main landing gear attached hydraulic components and lines for security and leakage.
9			Left and Right main landing gear tires for wear, cuts and proper inflation.
10			Aircraft brakes and brake lines for damage, leakage and missing parts and hardware.
11			Tailwheel for poor condition and security.
12			Skids, Floats or skis (if applicable) for security and obvious or apparent damage or defects.

Table A-6. Propeller(s)

Number	Complete	N/A	Inspection Items
1			Propeller(s) blades for damage, cracks, nicks, and gouges.
2			Propeller(s), spinner(s) and spinner after body(s) for damage, dents, nicks, and gouges.
3			Propeller assembly for oil leakage.
4			Hardware for looseness and broken or missing safeties.

Table A-7. Helicopter Rotor System

Number	Complete	N/A	Inspection Items
1			Main rotor, transmissions, and blades for obvious damage and fluid leakage.
2			Drive shafts and intermediate gearbox for obvious damage and fluid leakage
3			Tail rotor, transmissions, and blades obvious damage and fluid leakage.

Table A-8. Engine(s)

Number	Complete	N/A	Inspection Items
1			Engine(s) air inlet duct for damage, fluid leakage and loose or missing screws or rivets.
2			Engine(s) inlet guide vanes, compressor inlet variable vanes and visible fan blades for deformation, cracks, dents, nicks, gouges and damage. Notify AMARG Foreign Object Damage Manager if Foreign Object Damage is identified.

Table A-8. Engine(s) - Continued

Number	Complete	N/A	Inspection Items
3			Engine(s) for visual evidence of excessive oil and/or fuel leaks and sources of such leaks.
4			Engine mount(s) for cracks, looseness of mounting, and looseness of engine to mount.
5			Engine controls for defects, and improper safe-ing. Lines, hoses, and clamps for leaks, improper condition and looseness.
6			Cowling for cracks, and defects.
7			Accessories and gearboxes for apparent defects in security of mounting and proper servicing.
8			Engine oil tank for proper oil level. Service if required.
9			Exhaust pipe for cracks, defects, and improper attachment.
10			Engine exhaust area for foreign objects, lose or missing parts, leakage and damage. Check visible turbine blades for damaged cracked, gouges, nicks or missing blades.